

ESTABLISHED 1869



“ HEDGEHOG ” TOOLS

Telegrams:
“TOOLS”
CANNOCK



Telephone:
No. 2201
CANNOCK

2084

Sole Manufacturers :

CORNELIUS WHITEHOUSE and SONS, Ltd.

CANNOCK EDGE TOOL WORKS
CANNOCK • ENGLAND

This has been reproduced by kind
permission on the copy write
holders and descendants of
Mr. Oswald R.S.Whitehouse.



ESTABLISHED 1869
(CATALOGUE G 1152)



"HEDGEHOG" TOOLS

GOLD



MEDAL

Cornelius Whitehouse & Sons

LIMITED

CANNOCK EDGE TOOL WORKS
CANNOCK • STAFFS



Telephone: _____ CANNOCK No. 2201

Telegrams and Cables:— "TOOLS, CANNOCK"

Codes:—A.B.C. and BENTLEY'S

CORNELIUS WHITEHOUSE & SONS, Ltd.

TELEGRAMS: "TOOLS, CANNOCK."
CABLES: A.B.C. 5th EDITION AND BENTLEYS.
TELEPHONE: CANNOCK 2201.
PASSENGERS TO WYRLEY (B.R.).
GOODS TO CHURCHBRIDGE (B.R.).



CANNOCK EDGE TOOL WORKS,
CANNOCK, ENGLAND.

IN issuing this number of our Catalogue, we desire to thank our friends for their patronage and courtesies shown us in the past, and assure them that our sole aim is to cater to the needs of customers and to merit the same confidence in the future that has been enjoyed in the past.

An international reputation as leaders in the Auger and Edge Tool Business has been won by our wonderful success in designing new patterns, maintenance of quality, and determination to give the best service with practical results.

All Tools are severely tested before leaving our Factory, and the highest grade material and most experienced labour are employed in the production of our goods. In conclusion we beg to say that this Catalogue is the bona-fide product of our own labour and expense, and is copyright.

Cornelius Whitehouse & Sons, Ltd.



CONTRACTORS TO
THE WAR OFFICE, ADMIRALTY, INDIA OFFICE.
CROWN AGENTS FOR THE COLONIES,
FOREIGN GOVERNMENTS AND RAILWAYS.

JANUARY, 1952.

CANNOCK EDGE TOOL WORKS, CANNOCK.

CORNELIUS WHITEHOUSE & SONS, Ltd.

INDEX

	PAGE		PAGE		PAGE
Adzes, Carpenters'	7	Bill Hooks, Cratemakers'	20	Border Shears	11
.. Coopers'	7 Devon	19	Brace Bits, Various	1, 42
.. Fruit	7 Dorset	19 Centre	1, 42
.. Gum	7 Faggoting	18 Countersink	42
.. Guttering	7 Folkestone	17 Dowel	1
.. Joiners'	7 Gentleman's	18 Fast Sheeting	1
.. Spout	7 Hampshire	18 Fencing	1
.. Wheelers'	7 Hay	17 Rimer	42
Andyos	36 Hereford	17 Sash	2
Augers, Black Screw	3 Hertford	20 Shell	42
.. Eyed	2, 3 Hop	20 Wagon	1
.. Ladder	3 Kent	17 Wagon Builders'	1
.. Machine	1, 2 Knighton	17 In Sets	4
.. Shell	2 Leek	17	Bradawls	42
.. Ship	2, 3 Leominster	17, 20	Branch Shears	11
.. Tanged	2, 3 Lewes	18	Breast Knives	26
.. Taper Shell	3 Lincoln	20	Bricklayers' Tools	10, 31, 34, 39
Axes, Various	5, 6, 8, 26, 34 Llandilo	19	.. Bolsters	34
.. Broad	5 Llanidloes	17	.. Chisels	31
.. Coach	6 Llanio	19	.. Dressers	34
.. Coopers'	5 London Block	20	.. Hammers	34
.. Crate	6 Lopping	18	.. Hod Sockets	39
.. Deputy	6 Maidstone	18	.. Mortar Larry	39
.. Felling	5, 6 Monmouth	19	.. Mortar Picks	34
.. Hedging	5 Newport	17	.. Trowels	10
.. Irish	5 Newtown	17	.. Wall Drills	31
.. Joiners'	5 Norfolk	18	Broom Hooks, Banbury	20
.. Kent	5 Northwich	17 Leicester	20
.. Lincoln	6 Nottingham	20 Lincoln	20
.. Miners'	5 Offley	20 Nottingham	20
.. Mortice	6 Pontypool	17 Stafford	20
.. Northampton	5 Portsmouth	19	Browse Hooks	24
.. Pole	26 Rodding	18	Brushing Hooks 14, 15, 16, 21, 22, 23, 24	
.. Quarter Moon	6 Rutland	18 Abingdon	22
.. Scotch	5 Salisbury	18 Caergwrlle	22
.. Ship	6 Shifnal	17 Carlisle	16
.. Slaters'	34 Spar	19 Carnarvon	21
.. Squaring	6 Stafford	17, 20 Chester	23
.. Topping	6 Suffolk	20 Clare	16
.. Ty Gwyn	5 Tenterden	18 Derry	16
.. Wedge	6 Thatchers'	19 Ellesmere	23
.. Wheelers'	5 Tonbridge	17 General	15, 16, 23
.. Yorkshire	5 Ulverston	19 Hereford	15, 24
Bacon Knives	25 Westmoreland	18, 19 Irish	15, 16
Bagging Hooks, Various	21, 22 Woodstock	20 Kent	22
.. .. Dorset	21 Yorkshire	13 Lincoln	21
.. .. Hereford	22	Bits, Auger (see Brace Bits)	 Nenagh	15
.. .. Hook & Crook	22	Blacksmiths' Tools	29, 38 Newtown	14
.. .. Salop	22	.. Chisels	31 Pipe	22
Bean Hooks, Various	23	.. Cold Sets	38 Shaftesbury	22
.. .. Denbigh	23	.. Flatteners	38 Suffolk	24
.. .. Norfolk	23	.. Fullers	38 Wexford	16
Bench Holdfast	41	.. Hammers	29 Yorkshire	14
.. Stops	41	.. Hardies	38	Bruzzes, Wheelers'	42
Bill Hooks	17, 18, 19, 20	.. Hot Sets	38	Buffers, Farriers'	32
.. .. Aberayron	19, 20	.. Punches	38	Butchers' Tools	25, 26
.. .. Banbury	20	.. Set Hammers	38	.. Block Scrapers	25
.. .. Berkshire	17	.. Swages	38	.. Choppers	25
.. .. Bewdley	20	.. Tongs	38	.. Cleavers	26
.. .. Block	17, 20	Block Scrapers	25	.. Long Arms	26
.. .. Bristol	19	Boilermakers' Hammers	29, 30	.. Pig Hammers	26
.. .. Caergwrlle	17 Tongs	38	.. Pig Scrapers	26
.. .. Canterbury	17	Bolsters, Brick	34	.. Pole Axes	26
.. .. Chichester	17	.. Masons'	34		

CANNOCK EDGE TOOL WORKS, CANNOCK.

CORNELIUS WHITEHOUSE & SONS, Ltd.

INDEX—continued

	PAGE		PAGE		PAGE
Carpenters' Adzes	7	Cratemakers' Knives	20	Hammers, Bricklayers'	34
.. Augers	2, 3	Crow Bars	37	.. Canterbury	27
.. Axes	5, 8	Daisy Grubbers	10	.. Casemakers'	27
.. Bench Stops	41	Dandy Tools	10	.. Chisel End	30
.. Brace Bits	1, 2, 42	Docking Irons	10	.. Claw	27, 28
.. Chisels	42	Dowel Bits, Brace	1	.. Club	30
.. Cramps	40 Machine	1	.. Coachmakers'	29
.. Hammers	27	Drawing Knives	9	.. Coal	28
.. Hatchets	8	Dressers, Brick	34	.. Coopers'	29
.. Holdfasts	41	.. Miners	33	.. Crosspane	29, 30
.. Knives	9	Edging Irons	36	.. Double Face	29, 30
.. Pincers	42	.. Shears	11	.. Engineers'	29
Case Openers	28	Electricians' Chisels	31	.. Farmers'	28
Caulking Iron	31	Engineers' Chisels	31	.. Farriers'	27
Centre Bits	42	.. Hammers	29	.. Gardeners'	27
Chisels, Carpenters'	42	.. Vices	40, 41	.. Joiners'	27
.. Coppering	31	Eradicators, Weed	37	.. Keying	30
.. Electricians'	31	Eyed Augers	2, 3	.. Lathing	27
.. Engineers' Cold	31	Farriers' Buffers	32	.. Masons'	30, 34
.. Firmer	42	.. Crease	32	.. Mining	29, 30
.. Galvanised Iron	31	.. Hammers	27, 29	.. Napping	29
.. Masons'	34	.. Pincers	32	.. Orange Case	28
.. Plugging	31	.. Pritchells	32	.. Ox Shoeing	27
Choppers, Butchers'	25, 26	.. Punches	32	.. Packers'	28
.. Block	25	.. Stamp	32	.. Patternmakers'	27
.. Devon	25	.. Tongs	38	.. Platelayers'	30
.. Household	25	Fast Sheeting Bits	1	.. Quarry	29, 30
.. Irish	25	Felling Axes	5, 6	.. Riveting	27, 29
.. Lamb	25 Kent	5	.. Scaffolding	28
.. Meat	25 Wedge	6	.. Shoemakers'	28
.. Newcastle	25	Fen Hooks	14, 21	.. Shoe Turning	29
.. Scotch	25	Fencing Bits	1	.. Slaters'	28
.. Smithfield	25	Fireman's Axes	8	.. Sledge	29, 30
.. Stick	26	Firmer Chisels	42	.. Spalling	30
.. Turnip	39	Flatteners	38	.. Spiking	30
.. Wide	25	Forks, Turnip	39	.. Stone	29
.. Wood	26	.. Weed	10	.. Straightpane	29
Cleavers, Iron Handle	26	Froes, Coopers'	9	.. Tack	27
.. Scale Tang	26	Fruit Adzes	7	.. Tin Packers'	27
Clyburn Spanners	41	Fullers	38	.. Walling	30
Coal Hammers	28	Furze Hooks	16, 21, 23, 24	Hand Vices	40
.. Picks	33 Carrick	21	Handles, Bill Hook	17
.. Wedges	33 Dorset	23	Hatchets, Various	5, 8
Cocoa Pruners	19 Dungarvan	21	.. Miners'	5
Cold Sets	38 Kilkenny	21	Hay Knives	39
Colliers' Hammers	29 Llanelly	24	Hewing Hooks	24
.. Picks	33 Munster	21	Hod Sockets	39
Coopers' Tools	5, 9 Wexford	16, 21	Hoe Bows	39
.. Axes	5	Garden Shears	11	.. Blades	39
.. Chisels	9	.. Hoes and Tools	10, 11, 35, 37	Hoes, Various	35, 36, 37
.. Drivers	9	.. Reels and Pins	37	.. Andyo	36
.. Froes	9	Gimlets	42	.. Axe Eye	35
.. Hammers	29	Gorse Hooks	23, 24	.. Banbury	35
.. Hatchets	5 Aberayron	24	.. Bedford	35
.. Jiggers	9 Anglesey	23	.. Bury	35
.. Knives	9 Callington	23	.. Canterbury	35
.. Round Shaves	9 South Wales	23	.. Cardigan	35
Coppering Chisels	31	Grass Hooks	24	.. Diamond Eye	35
Cramps, Carpenters'	40	Grubbing Mattocks	32	.. Double Edge	36
.. Floor	41	Hammers	26, 27, 28, 29, 30, 34	.. Dutch	35
.. Joiners'	40	.. Adze Eye	27	.. Ely	35
.. G.	40	.. Ballarat	29, 30	.. Garden	35
.. Sash	40	.. Boiler Chipping	30	.. Newport	35
Cratemakers' Axes	6	.. Boilermakers'	29, 30	.. Potato	35, 37

CANNOCK EDGE TOOL WORKS, CANNOCK.

CORNELIUS WHITEHOUSE & SONS, Ltd.

INDEX—continued

	PAGE		PAGE		PAGE
Hoes, Preston	37	Mud Scrapers	39	Slashers, Manchester	14
.. Push	37	Napping Hammers	29	.. Pruning	13
.. Push-Pull	37	Navy Picks	33	.. Razor Blade	12
.. Rabbitters'	37	Onion Hoes	35	.. Scotch	13
.. Stalham	35	Paling Froes	9	.. Single Edge	12
.. Thistle	37	Parallel Vices	40	.. Spear Point	12
.. Triangle	35	Pea Hooks	24	.. Straight Cut	12
.. Wheat	35	Picks	33, 34	.. Yorkshire	13
.. Woodbridge	35	Pig Scrapers	26	.. Wexford	16
.. Yarmouth	35	Pincers, Carpenters'	42	Slaters' Tools	10, 28, 34
Hooks, Bagging, see Bagging Hooks		.. Farriers'	32	Sledge Hammers	29, 30
.. Bill, see Bill Hooks		Pin Mauls	30	Smiths' Tools	29, 31, 38
.. Broom, see Broom Hooks		Plasterers' Tools	10, 39	.. Tongs	38
.. Browse, see Browse Hooks		.. Trowels	10	Snips, Tinmen's	42
.. Brushing, see Brushing Hooks		Platelayers' Hammers	30	Spalling Hammers	30
.. Fen, see Fen Hooks		.. Spanners	31	Spanners	31, 41
.. Furze, see Furze Hooks		Pole Axes	26	Spuds	36
.. Gorse, see Gorse Hooks		Potato Hoes	35, 37	Stone Hammers	29
.. Hewing, see Hewing Hooks		Pruners	11	.. Masons' Chisels	34
.. Reaping, see Reaping Hooks		Punches, Gun Wad	40	Tanged Augers	2, 3
.. Trimming, see Trimming Hooks		.. Various	31, 32, 38	Thatchers' Bills	19
Hop Bills	20	Rabbitters' Hoes	37	Thistle Tongs	10
Joiners' Axes	5	Rakes	10	Thrifts	32
.. Cramps	40	Reaping Hooks	21, 22, 23	Tobacco Knives	9
.. Hammers	27	.. Bristol	23	Tongs	38
.. Hatchets	8	.. Caergwrlle	22	Triangle Hoes	35
Kent Axes	5	.. Hampshire	21	Trimming Hooks	24
Knives, Bacon	25	.. Llanelly	23	Trowels	10
.. Breast	26	.. Shropshire	22	.. Brick	10
.. Coopers'	9	.. Truro	23	.. Edinburgh	10
.. Drawing	9	Reels and Pins	37	.. Fern	10
.. Fish	25	Road Gads	37	.. Garden	10
.. Hay	39	.. Scrapers	39	.. Gauging	10
.. Mincing	9	Rounding Tools	38	.. Moulders'	10
.. Turnip	39	Sash Bits	2	.. Plasterers'	10
Lamp Spikes	33	Scrapers, Block	25	.. Pointing	10
Lathing Hammers	27	.. Pig	26	.. Slaters'	10
.. Hatchets	8	.. Road	39	.. Window	10
Line Pins	34	Shears, Garden	11	Tube Vices	41
Long Arms	26	Shell Augers	2	Turfing Irons	36
Machine Augers	2	.. Bits	42	Turnip Forks	39
.. Bits	1, 2	Ship Adzes	7	.. Hooks	39
Marlin Spikes	31	Shoe Turning Hammers	29	Twybills	7
Masons' Chisels	34	Slashers	12, 13, 14, 15, 16	Vices, Hand	40
.. Hammers	30, 34	.. Briar	14	.. Parallel	40
.. Trowels	10	.. Carlisle	16	.. Tube	41
Mattocks	32, 36	.. Curved Back	12	Wagon Bits	1
Mill Bills	32	.. Double Edge	13	Wall Drills	31
Mincing Knives	9	.. Dunse	12	Wedge Axes	6
Miners' Hammers	29, 30	.. Fen	12	Wedges, Wood Splitting	32
.. Hatchets	5	.. Full Back	13	.. Miners'	33
.. Lamp Spikes	33	.. Full Cutting Over	13	Weed Eradicators	37
.. Picks	33	.. Furze	14	.. Extractors	10
.. Tools	33	.. Grantham	12	.. Forks	10
.. Wedges	33	.. Half Back	13	.. Tongs	10
Mortar Larries	39	.. Half Cutting Over	13	Wood Choppers	26
.. Picks	34	.. Hand	13	Yorkshire Bills	13

For details of Numerical Code Index
see rear pages of catalogue.

CANNOCK EDGE TOOL WORKS, CANNOCK.

BRACE BITS

- A "Unbreakable" Brace Bits
 1 "Express" Brace Bits
 6 "Cabinet" Pattern Brace Bits
 7 "Scot" Brace Bits
 R "Pilot" Brace Bits
 B "Unbreakable" Dowel Bits
 6 A "Cabinet" Pattern Dowel Bits
 2 "Express" Dowel Bits
 RD "Pilot" Dowel Bits
 7 A "Scot" Fencing Bit, 12in.
 7 B "Scot" Fencing Bit, 14in.
 7 D "Scot" Fast Sheeting Bit
 7 F "Scot" Fast Sheeting Wagon Bit
 4 A "Express" Wagon Bit
 8 "Scot" Wagon Bit
 C "Unbreakable" Wagon Bit
 8 S "Scot" Wagon Bit, Square Shank, Black Twist
 472 Wagon Builders' Bit
 20 Fast Cutting Centre Bit



MACHINE DOWEL BITS

- BB "Unbreakable" Pattern
 6 C "Cabinet" Pattern
 RR "Pilot" Pattern

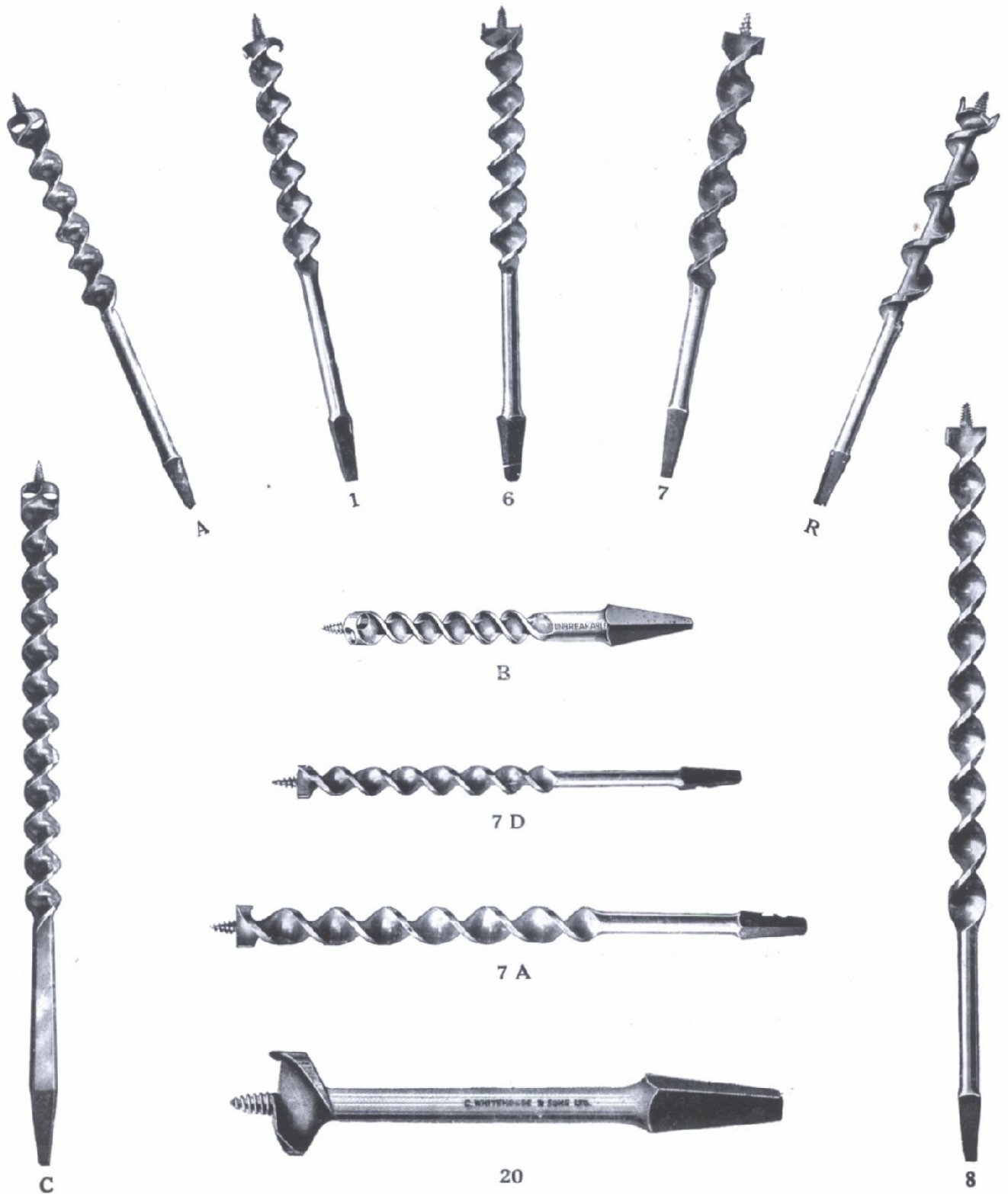

BRACE BITS AND AUGERS

- L "Unbreakable" Sash Bits, 18in.
- 1 G "Express" Sash Bits, 18in.
- 6 G "Cabinet" Pattern Sash Bits, 18in.
- E "Unbreakable" Tanged Auger
- 4 "Express" Tanged Auger
- 12 "Scot" Tanged Auger
- 14 Shell Auger, Tanged
- 14 A Shell Auger, Eyed
- 17 Shell Ship Auger, left for welding



MACHINE AUGERS

- AXB "Unbreakable" Pattern
- 1 XB "Express" Pattern
- 13 XB "Scot" Pattern



EYED AUGERS, &c.

- F "Unbreakable" Eyed Auger
- 5 "Express" Eyed Auger
- 13 "Scot" Eyed Auger
- 13 A "Scot" Square Shank Eyed Auger
- 6 E "Cabinet" Pattern Eyed Auger
- RE "Pilot" Eyed Auger
- 10 Black Screw Tanged Auger
- 11 Black Screw Eyed Auger
- 9 A Single Twist Ship Auger
- 9 S Single Twist Ship Auger, with Screw Point
- 19 Taper Shell Ladder Auger
- 9 C Single Twist Ship Auger, as 9 A, but Eyed
- 9 E Single Twist Ship Auger, as 9 S, but Eyed





F



10



19



11



13



Set No.	SETS OF BRACE BITS IN ROLLS
	Consisting of
R 100	1 each 4, 5, 6, 7, 8, 9, 10, 11, 12, 13, 14, 15, 16
R 107	1 each 4, 5, 6, 7, 8, 9, 10, 11, 12, 14, 16
R 115	1 each 4, 5, 6, 7, 8, 10, 12, 14, 16
R 124	1 each 4, 5, 6, 7, 8, 9, 10, 11, 12
R 133	1 each 4, 6, 8, 10, 12, 16



CANNOCK EDGE TOOL WORKS, CANNOCK.

SETS OF BRACE BITS IN ROLLS

High-class Material
and Workmanship.

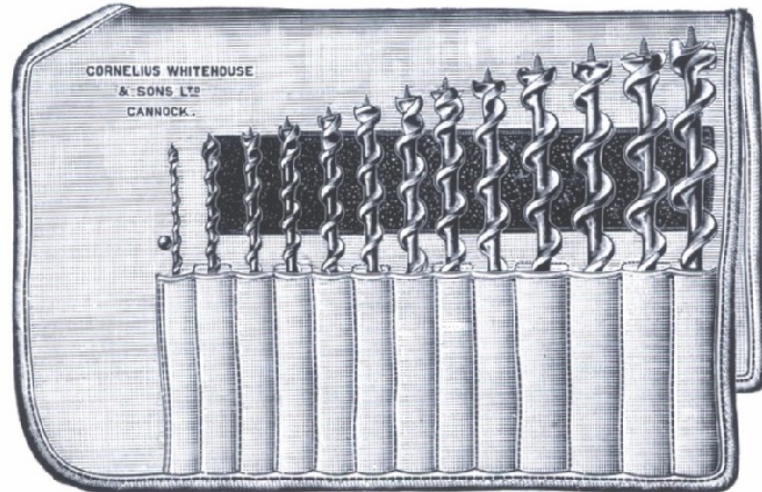

For Illustrations of
Various Types of
Brace Bits, see page
1 of this Catalogue.

Open Roll showing a 13 Set of Pilot Pattern



Each Bit being in a Separate Compartment the Points
and Cutters escape damage

SUPPLIED IN UNBREAKABLE, EXPRESS, CABINET, SCOT, OR PILOT PATTERN

Closed Roll.



Easily carried
in Pocket.

HEDGEHOG AXES

- 26 **Kent Axe**, Solid Steel
- 26 S **Kent Side Axe**, Solid Steel
- 26 A **Joiners' Axe**, Solid Steel, Handled
- 27 **Scotch Axe**, Solid Steel
- 27 H **Scotch Axe**, Solid Steel, Handled
- 28 **Yorkshire Axe**, Solid Steel
- 28 H **Yorkshire Axe**, Solid Steel, Handled
- 29 **Broad Axe**, Solid Steel
- 29 H **Broad Axe**, Solid Steel, Handled
- 29 N **Northampton Side Axe**, Solid Steel
- 35 **Broad Irish Axe**
- 35 H **Broad Irish Axe**, Handled
- 36 **Irish Axe**
- 36 H **Irish Axe**, Handled
- 37 **Hedging Axe**, Solid Steel
- 37 H **Hedging Axe**, Solid Steel, Handled
- 38 **Wheelers' Axe**, Solid Steel
- 41 W **Kent Felling Axe**, Solid Steel
- 42 **Moss Felling Axe**, Solid Steel
- 56 "Ty Gwyn" (Regd.) Solid Steel **Miners' Hatchet**
- 56 A "Ty Gwyn" (Regd.) Solid Steel **Miners' Hatchet**,
Handled
- CT 100 Solid Steel **Coopers' Axe**
- CT 104 Solid Steel **Coopers' Hatchet**



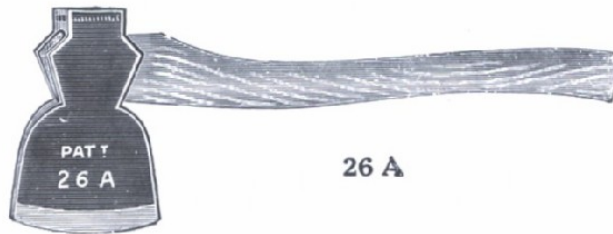
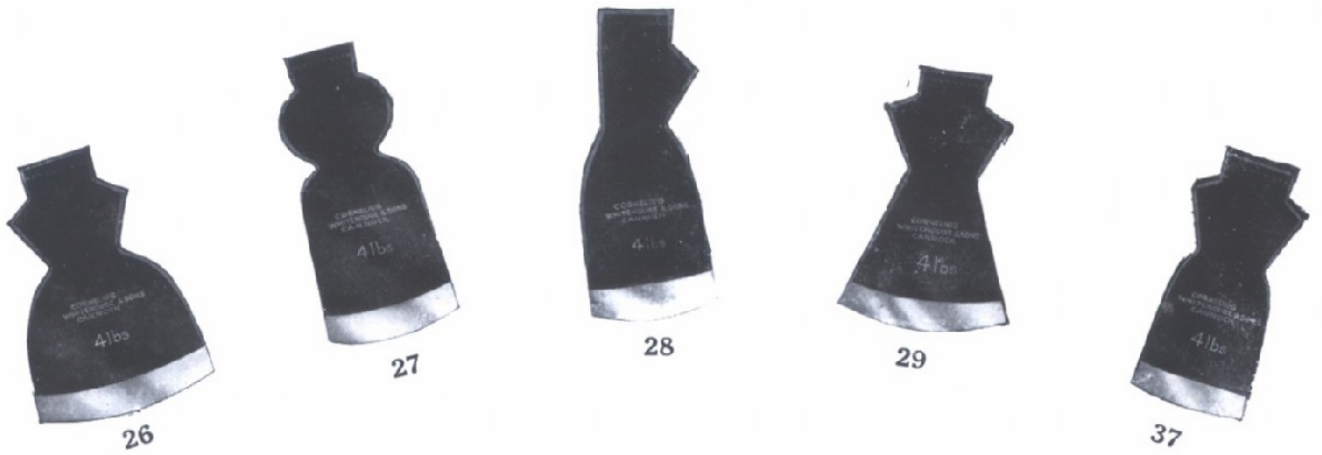

HEDGEHOG



TOOLS.



41 W



38

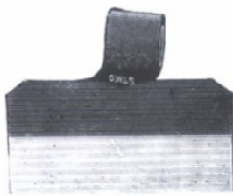

CT 100



56 A



CT 104

HEDGEHOG AXES

45	Ship Axe	*	57	Squaring Axe
50	Mortice Axe	*	58	Coach Axe
52	Deputy Axe	*	59	Quarter Moon Axe
53	Topping Axe	*	60	Crate Axe
53 H	Topping Axe	*	63	Wedge Pattern Axe
55	Lincoln Axe	*	63H	Wedge Pattern Axe, Handled
63 S	Wedge Pattern Axe, Handled, Second Finish			



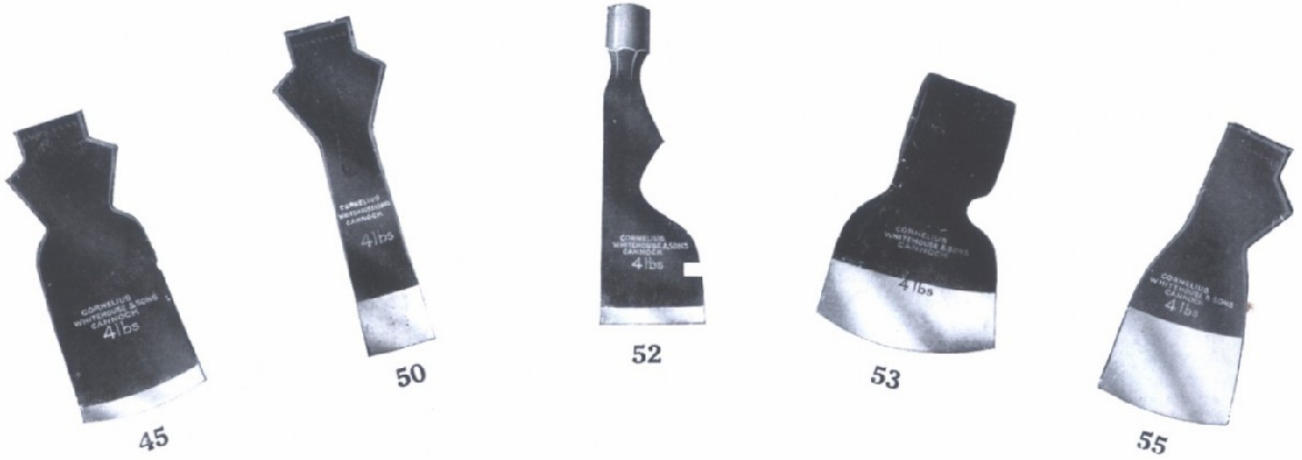

HEDGEHOG



TOOLS.

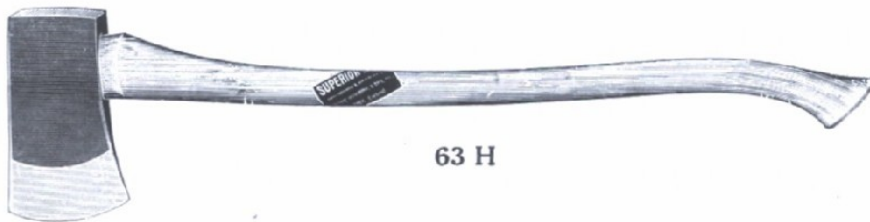

HEDGEHOG ADZES, &c.

- 78 Joiners' Adze
- 80 Ship Carpenters' Adze
- 84 Flat Head Wheelers' Adze
- 85 Joiners' Norfolk Adze
- 87 Spout or Guttering Adze
- 91 Gum Adze
- CT 109 Coopers' Sharp Adze
- CT 112 Coopers' Nail Adze
- 93 Fruit Adze, Handled, Forged Steel Quality
- 95 S Twybill, Solid Steel, Handled





HEDGEHOG



TOOLS.



HEDGEHOG HATCHETS

- 110 A **The "Gem" Hatchet**
- 111 **Steel Head Carpenter's Hatchet**
- 114 **Canadian Hatchet, Solid Steel, Best Finish**
- 114 C **Canadian Hatchet, Solid Steel, Second Finish**
- 123 A **Lathing Hatchet, Solid Steel, Octagon Head**
- 123 B **Lathing Hatchet, Solid Steel, Round Head**
- 850 **Lathing Hatchet, Solid Steel, Square Head**
- 124 **Shingling Hatchet, Solid Steel, Claw Head**
- 125 **Shingling Hatchet, Solid Steel, Octagon Head**
- 117 **Fireman's Hatchet, Scale Tang Handle**
- 118 A **Fireman's Hatchet, Langet Pattern Handle**



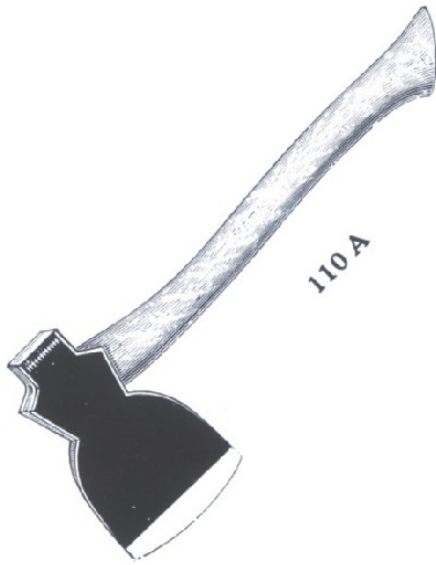

HEDGEHOG



TOOLS.

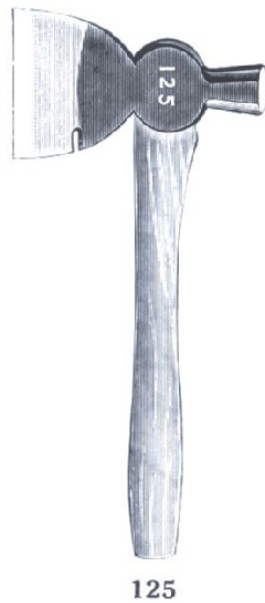
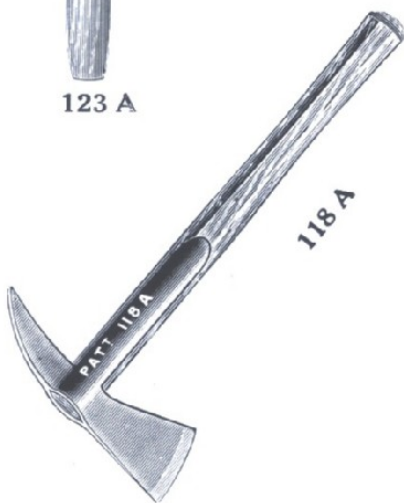

HEDGEHOG COOPERS' TOOLS,
DRAWING KNIVES, MINCE KNIVES, &c.

- 127 **Square Blade Riveted Mince Knife**, 6in.
 127 A **Half Round Blade Riveted Mince Knife**, 6in.
 129 **Square Blade Improved Mince Knife**, 6in.
 132 A **Half Round Blade Tobacco Cutter**
 CT 120 **Coopers' Driver**, Stocked and Hooped
 CT 124 **Coopers' Driver**, Shoes only
 CT 128 **Coopers' Driver**, Shoes only
 CT 130 **Coopers' Driver**, Solid Steel, 2½lb.
 CT 132 **Coopers' Flagging Iron**
 CT 172 **Coopers' Round Shave**
 CT 186 **Coopers' Steel Punch**
 CT 115 **Coopers' Cold Chisel**
 133 **Carpenters' Drawing Knife**
 139 **Carpenters' Drawing Knife**, Light
 139 D **Carpenter's Drawing Knife**, Fluted Blade
 (Egg-shaped Handles can also be supplied)
- CT 140 **Coopers' Straight Knife**, London pattern
 CT 141 **Coopers' Straight Knife**, Liverpool pattern
 CT 144 **Coopers' Heading Knife**
 CT 148 **Coopers' Reversed Crumming Knife**
 CT 152 **Coopers' Jigger**
 CT 156 **Coopers' Jigger**
 CT 163 **Coopers' Jigger**
 CT 164 **Coopers' Jigger**
 CT 176 **Coopers' Swift Iron**
 CT 180 **Coopers' Single Jointer Iron**, 11in.
 173 **Coopers' Froe**, Solid Steel
 1000 **Coopers' Froe**, Solid Steel, Heavy pattern





127

127



1000

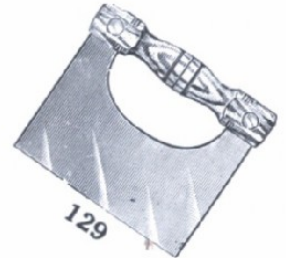

129



173

173

HEDGEHOG



CT 120



132 A

TOOLS.

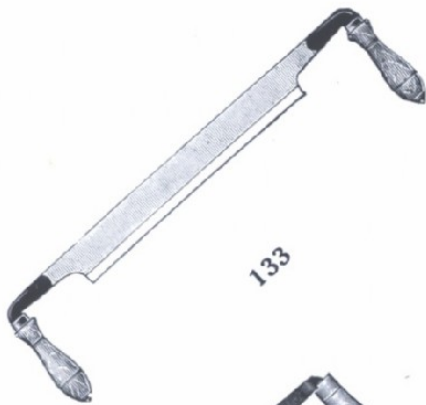

133



CT 130

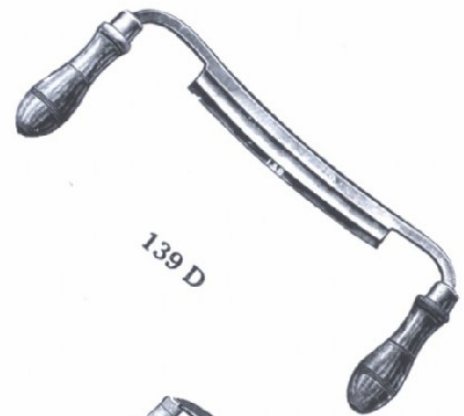

139 D



CT 140



CT 172



CT 152



CT 144

HEDGEHOG TROWELS, &c.

- 174 London Brick Trowel, Finest Cast Steel
- 174 A London Brick Trowel, Finest Cast Steel, Capped
- 174 D London Brick Trowel, Finest Cast Steel, Double Ferrules
- 178 Edinburgh Trowel, Finest Cast Steel
- 181 Slaters' Trowel, Finest Grade, Double Ferrules
- 182 Gauging Trowel, Finest Cast Steel
- 184 Pointing Trowel, Finest Cast Steel
- 185 Pointing Trowel, Finest Cast Steel, Broad pattern
- 188 Moulders' Trowel, Finest Cast Steel
- 189 A Window Trowel, Finest Cast Steel
- 195 Garden Trowel, Riveted, Bright and Painted
- 196 Garden Trowel, Solid, Bright and Painted
- 196 S Garden Trowel, Steel, Socket
- 196 F Fern Trowel, Bright, Hardwood Handle
- 203 Garden Fork, Steel, 3-prong, Bright and Painted
- 204 Daisy Lifters, 18in. Handle
- 204 B Daisy Lifters, Socket, Handled
- 204 D Daisy Lifters, Bent Steel
- 191 Plasterers' Trowel, Single Hang, 10 Rivets
- 192 Plasterers' Trowel, Double Hang, 6 Rivets
- 198 Garden Rakes
- 198 A Garden Rakes, fitted with Ash Handles
- 200 "Dandy" Weed Extractor
- 205 Dock Drawers, strong T Handles
- 205 A Weed or Thistle Tongs



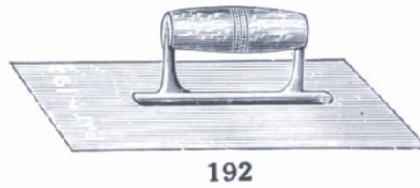
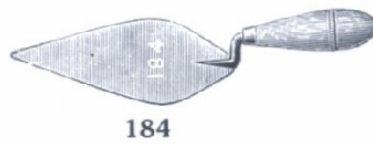

HEDGEHOG



TOOLS.

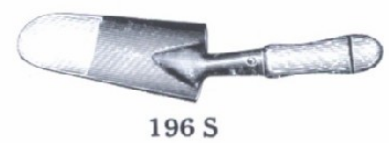
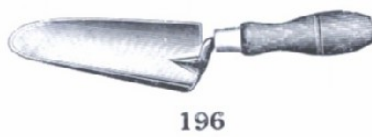

HEDGEHOG EVERTITE GARDEN SHEARS

“ Hedgehog ” Garden Shears

- 206** Plain Blades
206 A Notched
209 Ladies’
209 M Ladies’ “ Peter Pan,” 4½in.
206 B “ Cottager,” Lightweight, 8in.

“ Hedgehog ” Border Shears

- 207** Without Wheel
207 A Fitted with Wheel

“ Hedgehog ” Lawn Shears

- 210 L** Without Wheels
210 W Fitted with Wheels

All the above mentioned Shears are fitted with Bolt and Nut and Spring Washer

“ Hedgehog ” Pruners

- 208** Strong Pruner, 28in. Handles
208 A Medium Pruner, 24in. Handles
210 Light Pruner, 15in. Handles

Shears or Pruners if Pinned through Handles, Extra
Shears fitted with Wing Nuts, Extra

Sundry Fittings for “ Hedgehog ” Shears and Pruners

- 206 P** Bolt and Nut for Garden, Lawn or Border Shears
209 P Bolt and Nut for Ladies’ Shears
206 S Spring Washer for Garden, Lawn or Border Shears
209 S Spring Washer for Ladies’ Shears
206 X Ferruled Handle for Garden Shears, **206**
209 X Ferruled Handle for Ladies’ Shears, **209**
208 X Ferruled Handle for Pruners, **208**
208 AX Ferruled Handle for Pruners, **208A**
210 X Ferruled Handle for Pruners, **210**
207 X Ferruled Handle for Border or Lawn Shears, 36in.





206 A



208



206 A

HEDGEHOG



TOOLS.



207 A

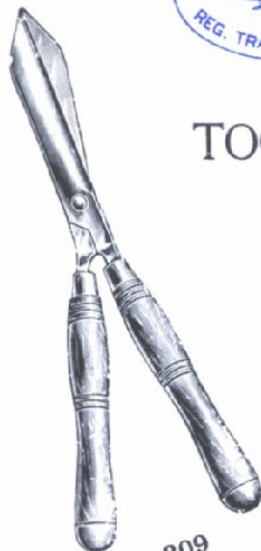

209

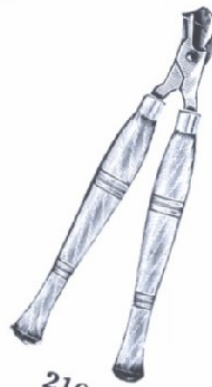

210



210 L

THE WHITEHOUSE SLASHER HEDGEHOG BRAND

213	Single Edge, Heavy
213 HP	Single Edge, Medium
213 H	Single Edge, Light
213 D	Single Edge, Dunse
213 F	Single Edge, Featherweight
213 A	Single Edge, Heavy, fitted with Ring and Bolt
215	Single Edge, Fen Pattern, Light
215 D	Single Edge, Fen Pattern, Dunse
215 F	Single Edge, Fen Pattern, Featherweight
220	Single Edge, Grantham Pattern, Light, Bright
220 M	Single Edge, Grantham Pattern, Medium, Bright
220 G	Single Edge, Grantham Pattern, Heavy, Bright
221	Single Edge, Straight Cut, Heavy
221 M	Single Edge, Straight Cut, Medium
221 L	Single Edge, Straight Cut, Light
221 D	Single Edge, Straight Cut, Dunse
221 F	Single Edge, Straight Cut, Featherweight
221 A	Single Edge, Spear Point, Light
221 E	Single Edge, Spear Point, Dunse
221 C	Single Edge, Spear Point, Featherweight
225	Single Edge, Curved Back, Heavy
225 M	Single Edge, Curved Back, Medium
225 L	Single Edge, Curved Back, Light
225 D	Single Edge, Curved Back, Dunse
225 F	Single Edge, Curved Back, Featherweight
227	Single Edge, Dunse Bill



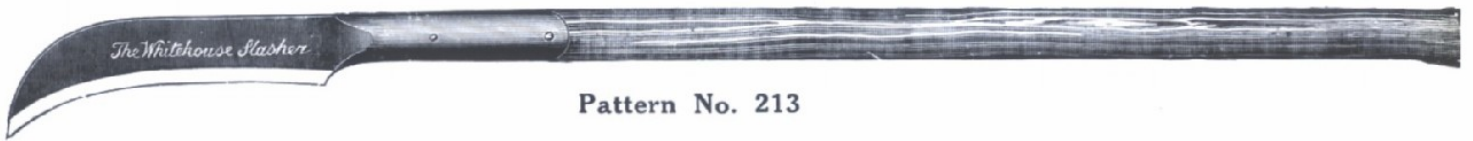

Pattern No. 213



Pattern No. 213 HP



Pattern No. 215



Pattern No. 220

HEDGEHOG



SLASHERS.



Pattern No. 221



Pattern No. 221 A



Pattern No. 225



Pattern No. 227

THE WHITEHOUSE SLASHER
HEDGEHOG BRAND

O 227 Light Pruning Bill, Bright and Blued

O 228 Half Cutting-over Bill, Bright and Blued

O 229 Full Cutting-over Bill, Bright and Blued



222 Hand Slasher, Single Edge

223 Hand Slasher, Half Back

217 Half Back Slasher, Heavy

217 A Half Back Slasher, Heavy, fitted with Ring and Bolt

217 M Half Back Slasher, Medium Weight

217 B Full Back Slasher, Heavy

217 BA Full Back Slasher, Heavy, fitted with Ring and Bolt

217 E Full Back Slasher, Medium Weight

218 Double Edge Slasher, Heavy

218 M Double Edge Slasher, Medium Weight

230 Yorkshire Pattern Bill, Single Edge

231 Yorkshire Pattern Bill, Full Back





Pattern No. O 227



Pattern No. O 228



Pattern No. O 229

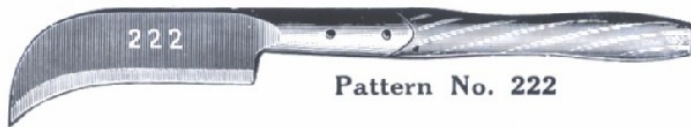

Pattern No. 222



Pattern No. 223

HEDGEHOG



SLASHERS.

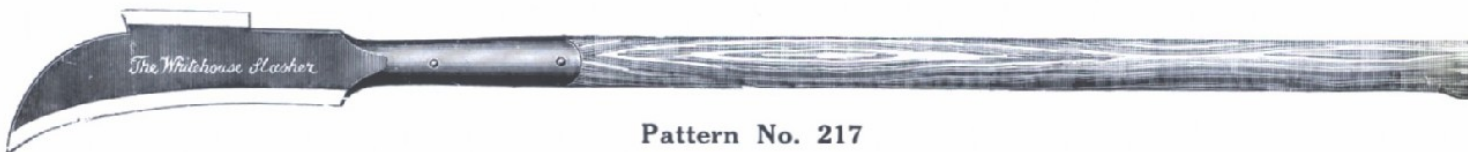

Pattern No. 217

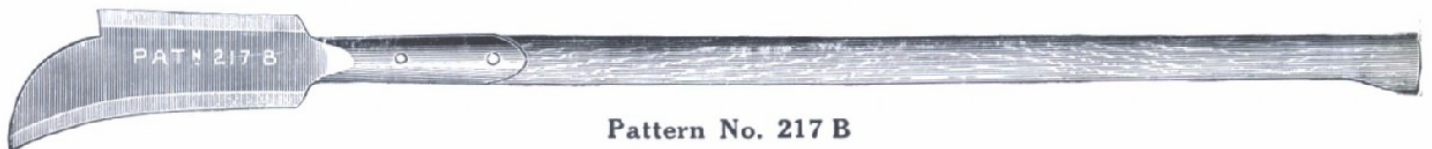

Pattern No. 217 B

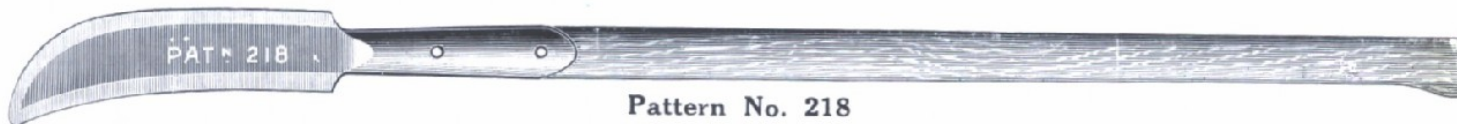

Pattern No. 218



Pattern No. 231

THE WHITEHOUSE HEDGEHOG BRAND

BRUSHING HOOKS & SLASHERS

- 219 **Manchester Slasher**
- 226 **Furze Slasher**
- 226 A **Furze Slasher**, fitted with Ring and Bolt
- 226 B **Briar Slasher**
- * * * * * *
- 255 **Fen Hook**, Socket
- 255 T **Fen Hook**, Tanged and Ferruled
- 256 **Yorkshire Hook**, Tanged and Ferruled
- 256 S **Yorkshire Hook**, Socket
- 256 W **Newtown Brushing Hook**, Tanged and Ferruled





Pattern No. 255



Pattern No. 255 T



Pattern No. 256

HEDGEHOG



TOOLS.



Pattern No. 256 W



Pattern No. 226



Pattern No. 226 B

THE WHITEHOUSE HEDGEHOG BRAND
BRUSHING HOOKS & SLASHERS

- 232 A** **Nenagh Brushing Hook**, Tanged and Ferruled
- 232 S** **Nenagh Brushing Hook**, Strapped
- 257** **Irish Brushing Hook**, Light, Tanged and Ferruled
- 257 S** **Irish Brushing Hook**, Light, Strapped
- 292 A** **General Pattern Brushing Hook**
- 292 B** **General Pattern Brushing Hook**, fitted with Ring
and Bolt
- 292 SR** **General Pattern Brushing Hook**, Straighter Blade
- 292 SX** **General Pattern Brushing Hook**, Straighter Blade,
fitted with Ring and Bolt
- 292 M** **Hereford Pattern Brushing Hook**, Bright Oval
Socket, 36in. Handle





232 A



257



257 S

HEDGEHOG



TOOLS.

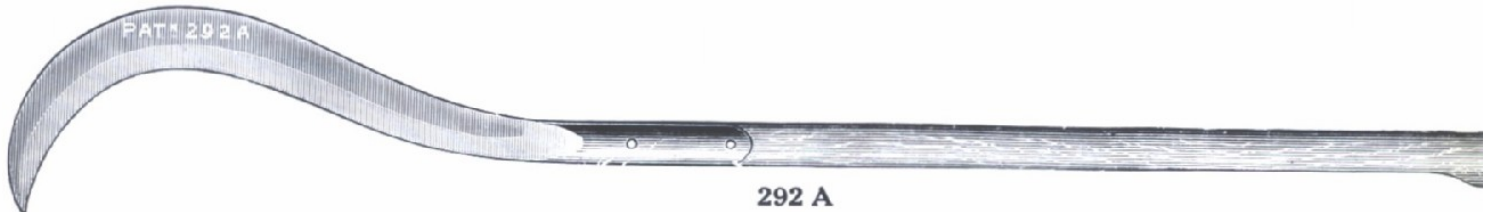

292 A



292 SR



292 M

THE WHITEHOUSE HEDGEHOG BRAND

BRUSHING HOOKS & SLASHERS

- 716** **General Pattern Brushing Hook**, Open Socket
- 720** **General Pattern Brushing Hook**, Medium Weight,
Open Socket
- 294 S** **Derry Pattern Brushing Hook**, Improved Socket,
Medium Weight
- 722 C** **Carlisle Pattern Brushing Hook**, Tanged and Long
Ferrule
- 724 C** **Carlisle Pattern Brushing Hook**, Improved Socket
- H 100** **Irish Pattern Brushing Hook**, Strong
- H 200** **Clare Pattern Brushing Hook**
- B 18** **Wexford Slashing Hook**, Tanged and Ferruled
- B 19** **Irish Slashing Hook**, Medium, Improved Socket
- B 19 A** **Irish Slashing Hook**, as **B 19**, but Tanged and Ferruled





Pattern No. 716



Pattern No. 720

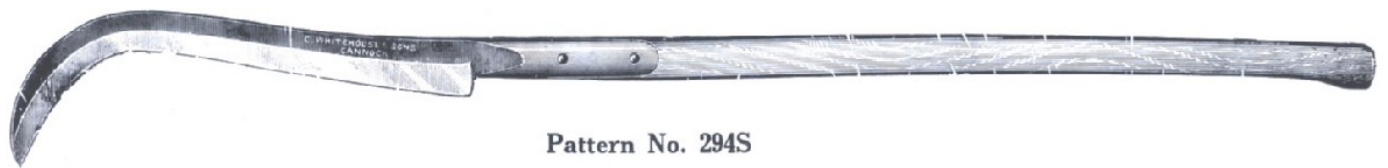

Pattern No. 294S

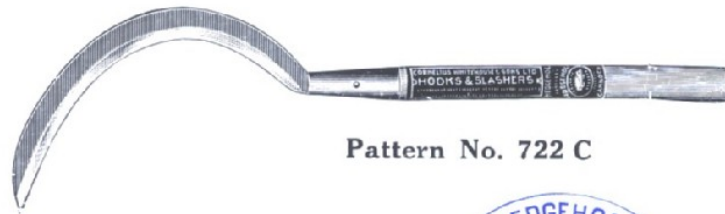

Pattern No. 722 C

HEDGEHOG



TOOLS.



Pattern No.
H 100



Pattern No. B 19



Pattern No. 724 C



Pattern No. B 18

HEDGEHOG BILL HOOKS

234	Newtown	*	241	Berkshire
234 P	Newtown, Peaked	*	242	Chichester
235	Northwich	*	244	Pontypool
236	Newport	*	245	Block
237	Leominster	*	247	Folkestone
238	Hereford	*	248	Canterbury
239	Kent	*	250	Tonbridge
239 S	Kent Socket, not handled	*		Leek
240	Stafford	*		Caergwrlle
	Shifnal	*		Llanidloes
	Knighton	*		Hay



BILL HOOK HANDLES

Round Pattern, Ferruled

Caulked Pattern, Ferruled

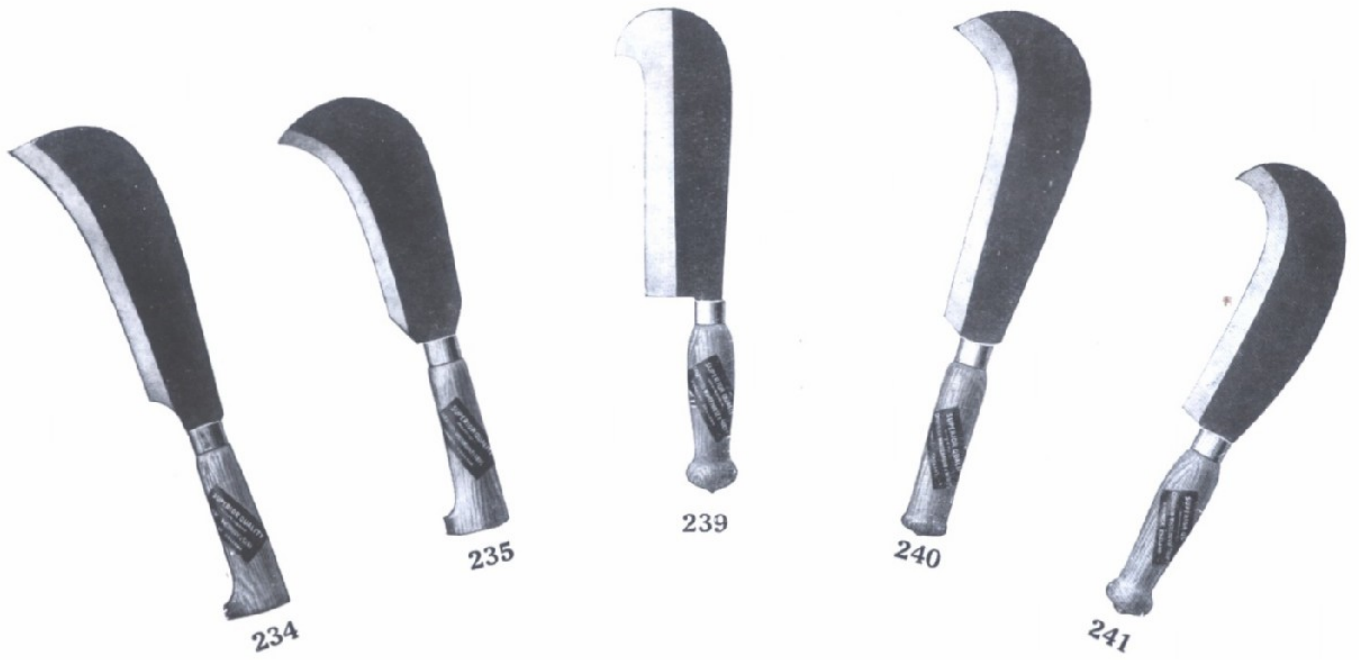

HEDGEHOG



TOOLS.

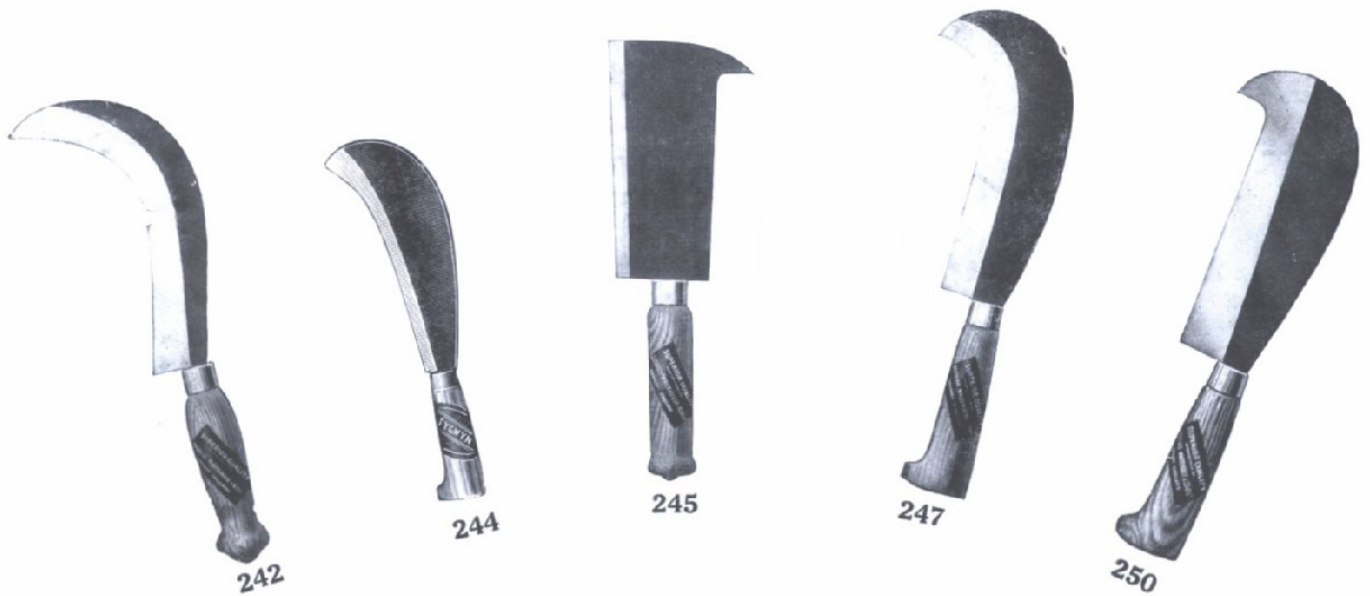

HEDGEHOG BILL HOOKS

- 251 **Hampshire**
- 252 **Norfolk**
- 254 **Faggoting**
- 1100 **Gentleman's, All Bright Blade**
Gentleman's, with Back, All Bright
- 1102 **Tenterden, Self Colour**
- 1102 S **Tenterden, Stone Finish**
- 1104 **Lewes, Self Colour**
- 1104 S **Lewes, Stone Finish**
- 1106 **Maidstone, Self Colour**
- 1106 S **Maidstone, Stone Finish**
- 1108 **Rutland**
- 1109 **Rutland, Peaked on Back**
- 1110 **Rodding**
- 1110 A **Rodding, with Weighted End**
- 1112 **Lopping**
- 1113 **Salisbury**
- 1114 **Westmoreland**





HEDGEHOG



TOOLS.

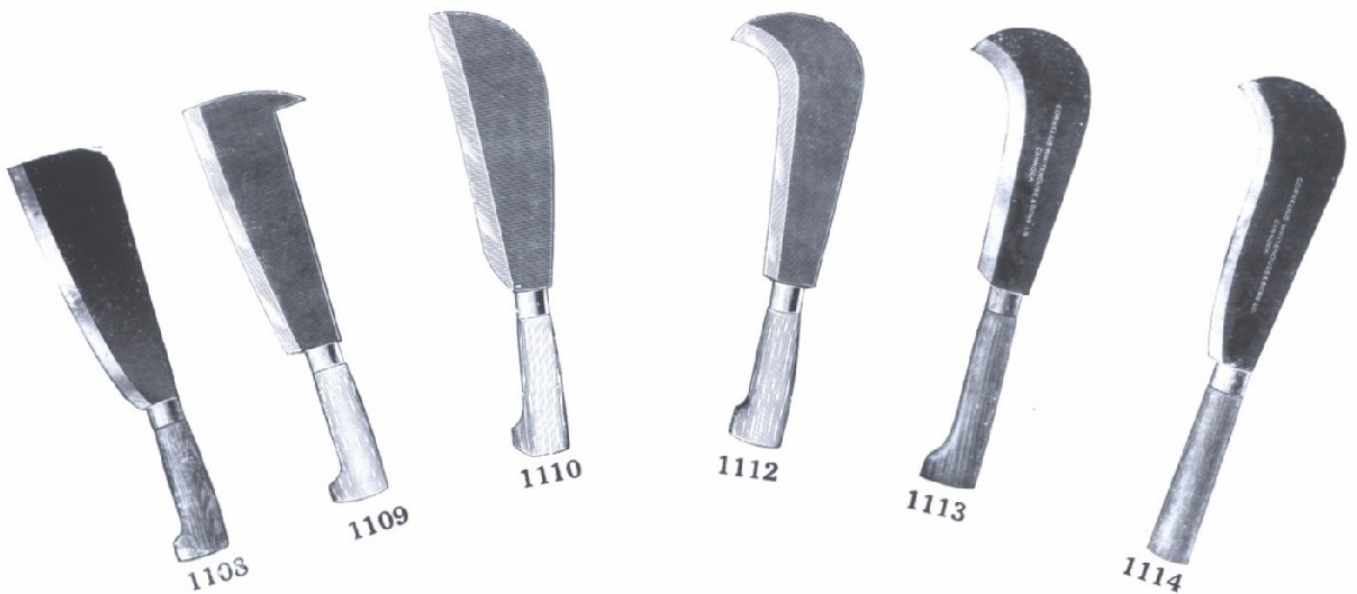

HEDGEHOG BILL HOOKS, &c.

- 1115 Westmoreland, with Back Edge
- 1116 Bristol
- 1117 Portsmouth
- 1118 Devon Spar
- 1120 Devon
- 1121 Dorset
- 1122 Ulverston
- 1123 Thatchers'
- 1124 Thatchers, Peaked
- 1145 Aberayron
- 1146 Llanio, Round Handles
- 1147 Llanio, Oval Handles
- 1149 Llandilo
- 1149 S Llandilo, Socket and Handled
- 1151 Monmouth
- 544 Cocoa Pruner



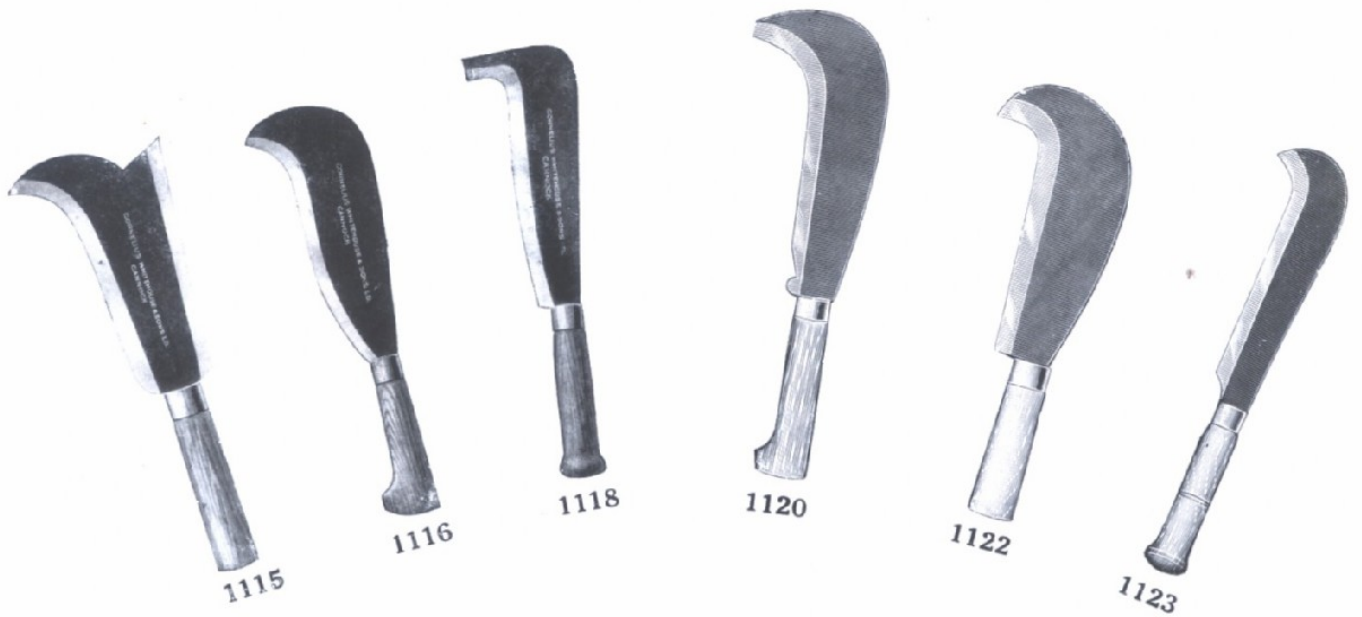

HEDGEHOG



TOOLS.

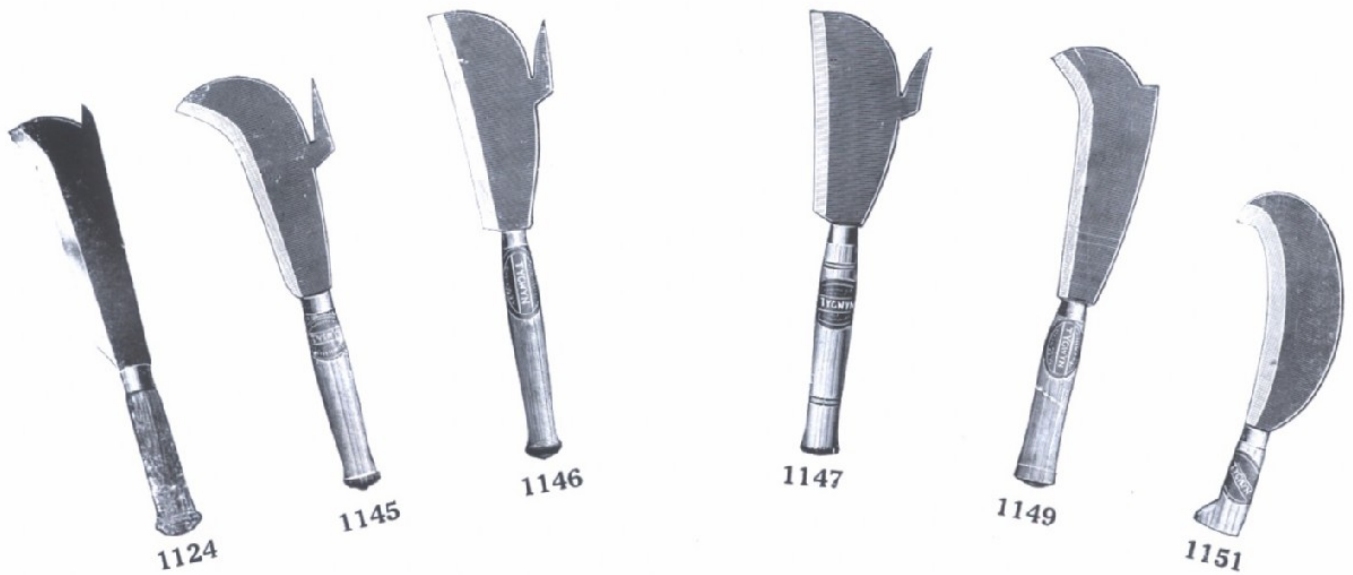

HEDGEHOG HOOKS

463	Cratemakers' Bill
464	Cratemakers' Mortice Knife
1175	Aberayron Socket Bill
1175 H	Aberayron Socket Bill, Handled
253	Suffolk Bill, Handled
260	Lincoln Broom Hook
261	Leicester Broom Hook
263	Nottingham Broom Hook
264	Stafford Broom Hook
265	Offley Large Socket Bill
265 H	Offley Large Socket Bill, Handled
266	Offley Small Socket Bill
266 H	Offley Small Socket Bill, Handled
271	Banbury Broom Hook
276	London Block Bill, Socket, Peaked, not Handled
276 A	London Block Bill Socket, without Peak, not Handled
281	Hertford Full Edge Bill
281 H	Hertford Full Edge Bill, Handled
282	Hertford Straight Edge Bill
282 H	Hertford Straight Edge Bill, Handled
285	Woodstock Socket Bill, not Handled
	Leominster Socket Bill, not Handled
	Leominster Socket Bill, Handled
	Bewdley Socket Bill, not Handled
	Socket Hop Bills, not Handled



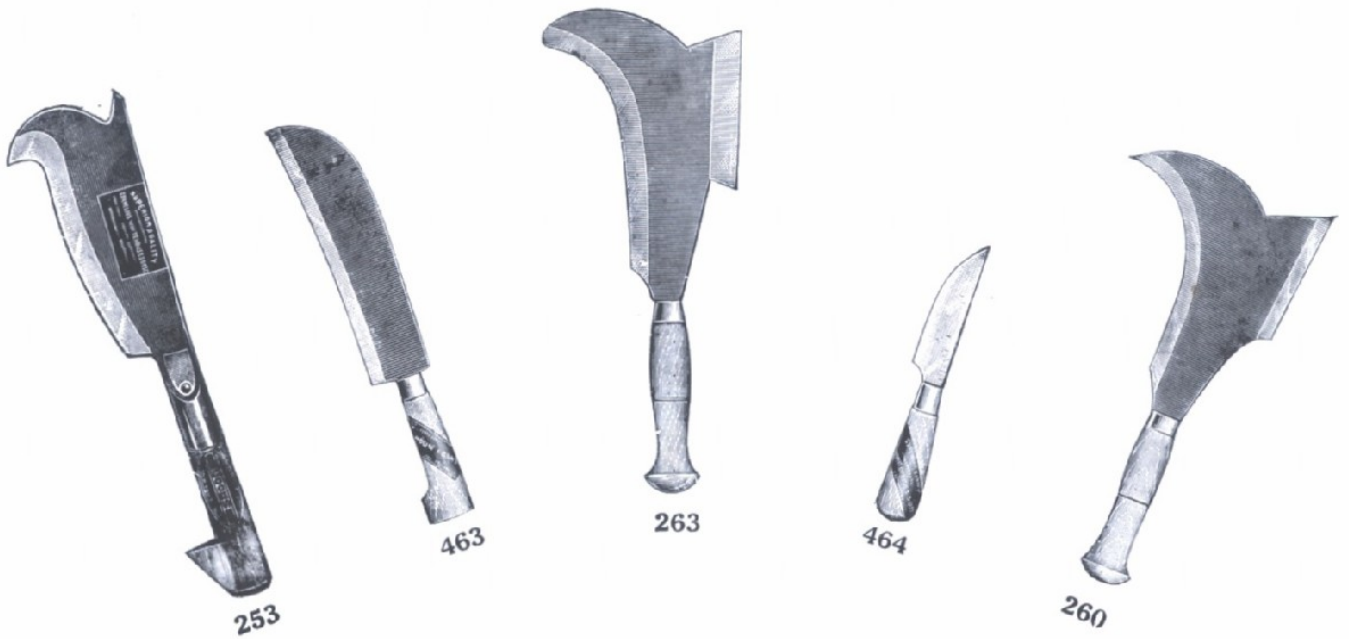

HEDGEHOG



TOOLS.

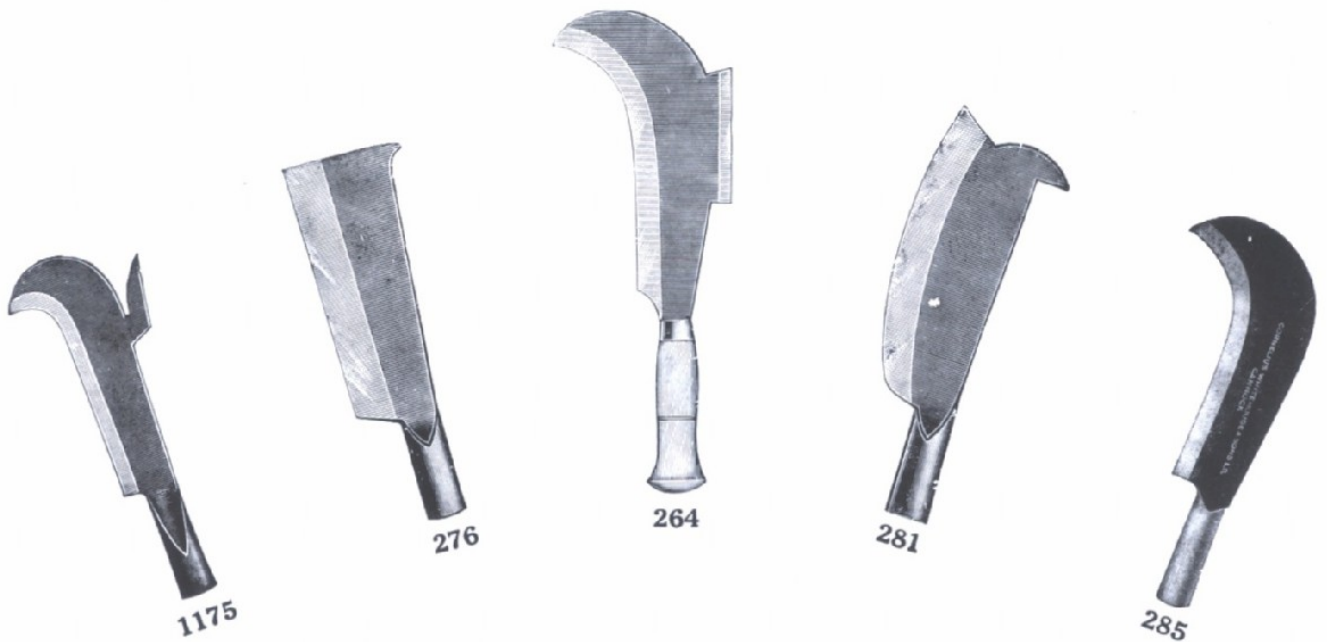

HEDGEHOG FURZE AND BRUSHING HOOKS

- 287 **General Pattern, Furze Hook, Plain**
- 287 A **General Pattern Furze Hook, Cranked**
- 287 D **Dungarvan Pattern Furze Hook, Plain**
- 287 E **Dungarvan Pattern Furze Hook, Cranked**
- 287 K **Kilkenny Pattern Furze Hook, Plain**
- B 22 **Munster Pattern Furze Hook, Plain**
- B 22 A **Munster Pattern Furze Hook, Cranked**
- B24 **Carrick Pattern Furze Hook, Plain**
- B 24 A **Carrick Pattern Furze Hook, Cranked**
- B 24 L **Carrick Pattern Furze Hook, Plain, Large**
- B 26 **Wexford Pattern Furze Hook**
- B 18 **Wexford Pattern Furze Hook**
 Long Handles (Illustrated on page 16)
- 1200 **Dorset Bagging Hook**
- 1202 **Dorset Bagging Hook, Cranked**
- 1204 **Dorset Bagging Hook, Cranked, Caulked Handles**
- 1206 **Dorset Bagging Hook, Open Blade**
- 1208 **Lincoln Fen Hook**
- 1210 **Carnarvon Brushing Hook**
- 1212 **Carnarvon Brushing Hook, Narrow Point**
- 1214 **Hampshire Reaping Hook**
- 1216 **Hampshire Reaping Hook, Cranked**



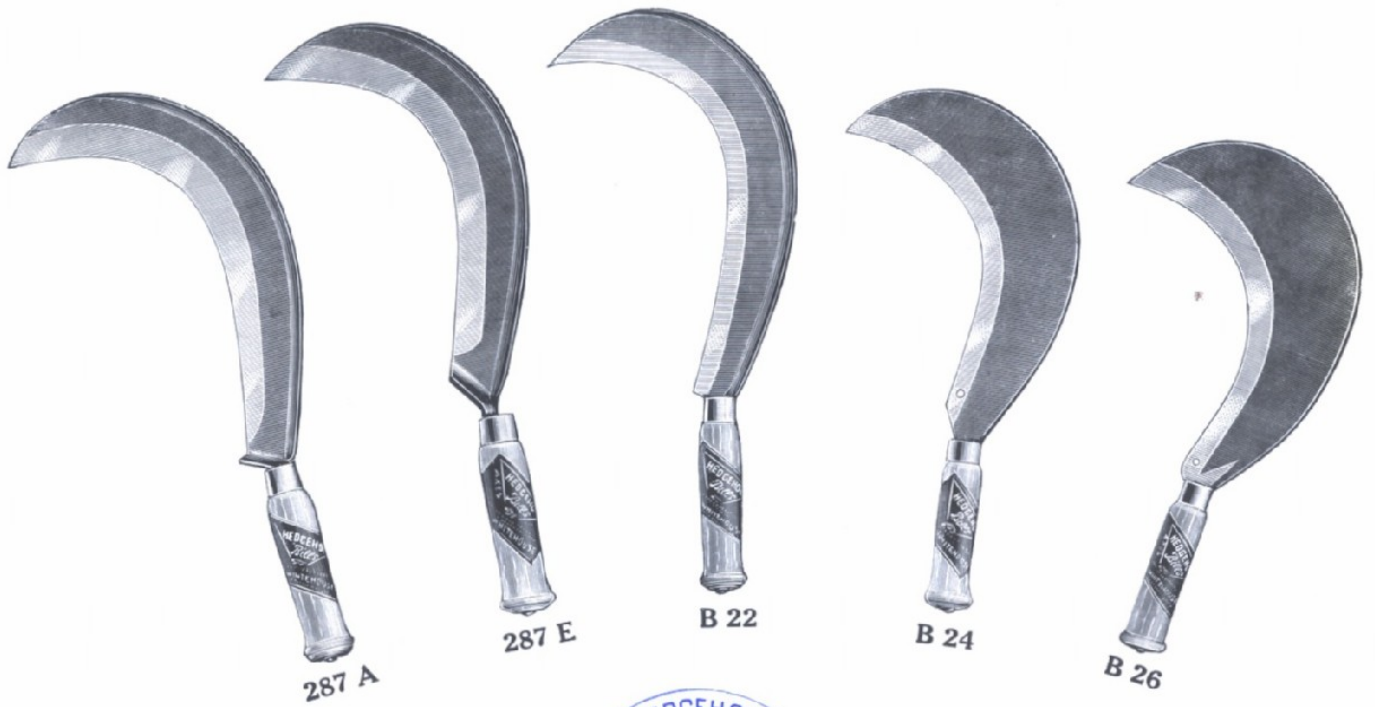

HEDGEHOG



TOOLS.

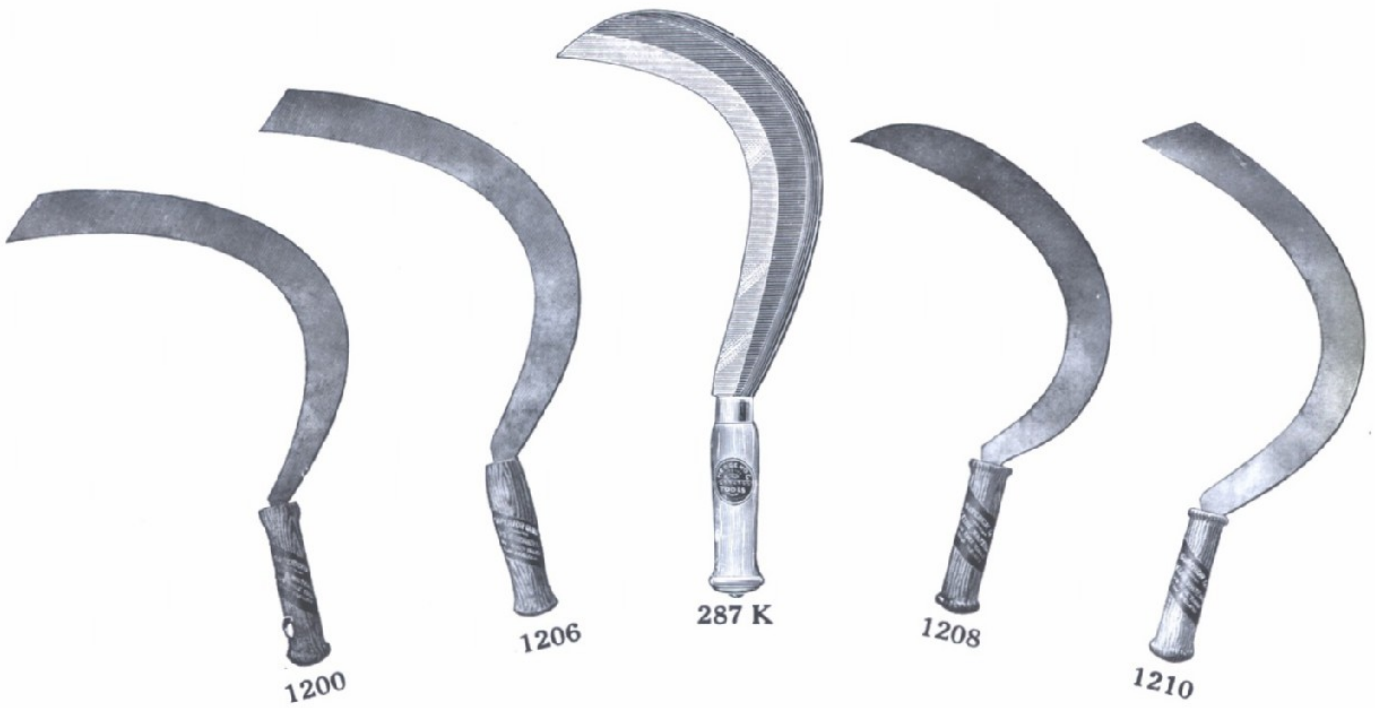

HEDGEHOG REAPING, BAGGING AND BRUSHING HOOKS

- 1218 Salop Pattern Bagging Hook
- 1222 Shaftesbury Pattern Brushing Hook
- 1224 Shaftesbury Pattern Brushing Hook, Cranked
- 1226 Shaftesbury Pattern Brushing Hook, Cranked
and Caulked
- 1228 Hereford Pattern Bagging Hook
- 1230 Shropshire Pattern Reaping Hook
- 1232 Pipe Pattern, Half Bright Hook, Ferruled
- 1234 Pipe Pattern Half Bright Hook, not Ferruled
- 1234 A Pipe Pattern Half Bright Hook, Light
- 1236 Caergwle Pattern Reaping Hook, Ferruled
- 1238 Caergwle Pattern Reaping Hook, not Ferruled
- 1240 Abingdon Pattern Brushing Hook
- 1242 Abingdon Pattern Brushing Hook, Cranked
- 1248 Kent Pattern Brushing Hook, Bright Side
- 1250 Caergwle Pattern Brushing Hook, Bright Side
- 1244 Hook and Crook Pattern Bagging Hook
- 1246 Hook and Crook Pattern Bagging Hook, Cranked





HEDGEHOG



TOOLS.



HEDGEHOG REAPING AND BRUSHING HOOKS

- 1251 **General Pattern Brushing Hook**, Bright Side
- 1252 **Chester Pattern Brushing Hook**, Bright Side
- 1253 **Truro Pattern Reaping Hook**
- 293 **Norfolk Pattern Bean Hook**, Ferruled
- 1254 **Norfolk Pattern Bean Hook**, not Ferruled
- 1255 **Denbigh Pattern Bean Hook**, not Ferruled
- 1256 **Denbigh Pattern Bean Hook**, Ferruled
- 1257 **Anglesey Pattern Gorse Hook**
- 1258 **Ellesmere Pattern Brushing Hook**, 15in.
- 1260 **Cowbridge Pattern Edging Hook**, Caulked
- 1262 **Callington Pattern Gorse Hook**
- 1264 **West Country Pattern Bramble Hook**, Light
- 1266 **Bristol Pattern Reaping Hook**, Superior Grade
(Ferruled)
- 1266 A **Bristol Pattern Reaping Hook**, Special Grade
- 1268 **Llanelly Pattern Reaping Hook**
- 1270 **Dorset Pattern Furze Hook**, Dished
- 1272 **Dorset Pattern Furze Hook**, Dished, with Caulked
Handles
- South Wales Gorse Hooks**





HEDGEHOG



TOOLS.

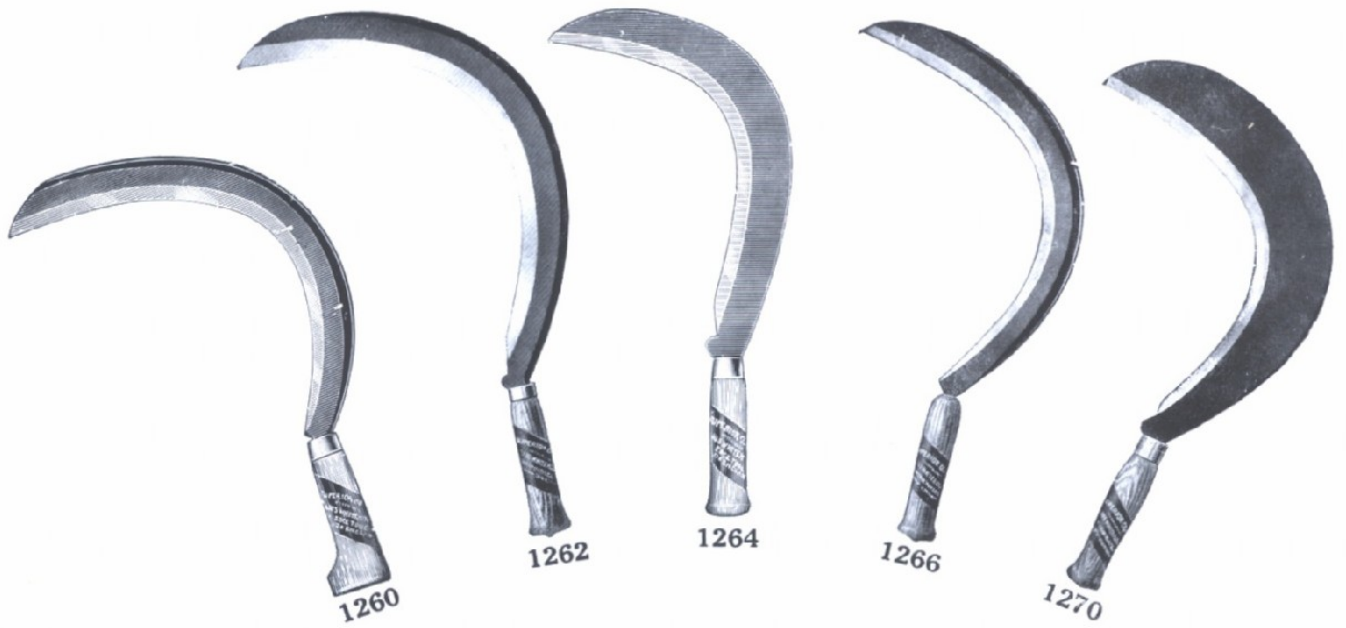

HEDGEHOG BRUSHING HOOKS, &c.

- | | |
|-------|--|
| 1274 | Bristol Pattern Hewing Hook |
| 1276 | Bristol Pattern Hewing Hook , Cranked |
| 1278 | Aberayron Pattern Gorse Hook |
| 1280 | Llanelly Pattern Furze Hook |
| 1282 | North Devon Pattern Browse Hook |
| 1284 | West Country Pattern Hand Reap Hook |
| 1286 | Grass Hook , Cranked and Ribbed |
| 1288 | Trimming Hook , Ribbed, Straight |
| 1289 | Trimming Hook , Ribbed, Cranked |
| 1330 | Socket Staff Hook , Plain Blade |
| 1331 | Socket Staff Hook , Ribbed |
| 292 | Pea or Brushing Hook |
| 292 D | Hereford Pattern Brushing Hook |
| 292 J | Hereford Pattern Brushing Hook (shape as 292 D),
Oval Socket, 36in. Handle |
| 317 | Suffolk Pattern Brushing Hook |



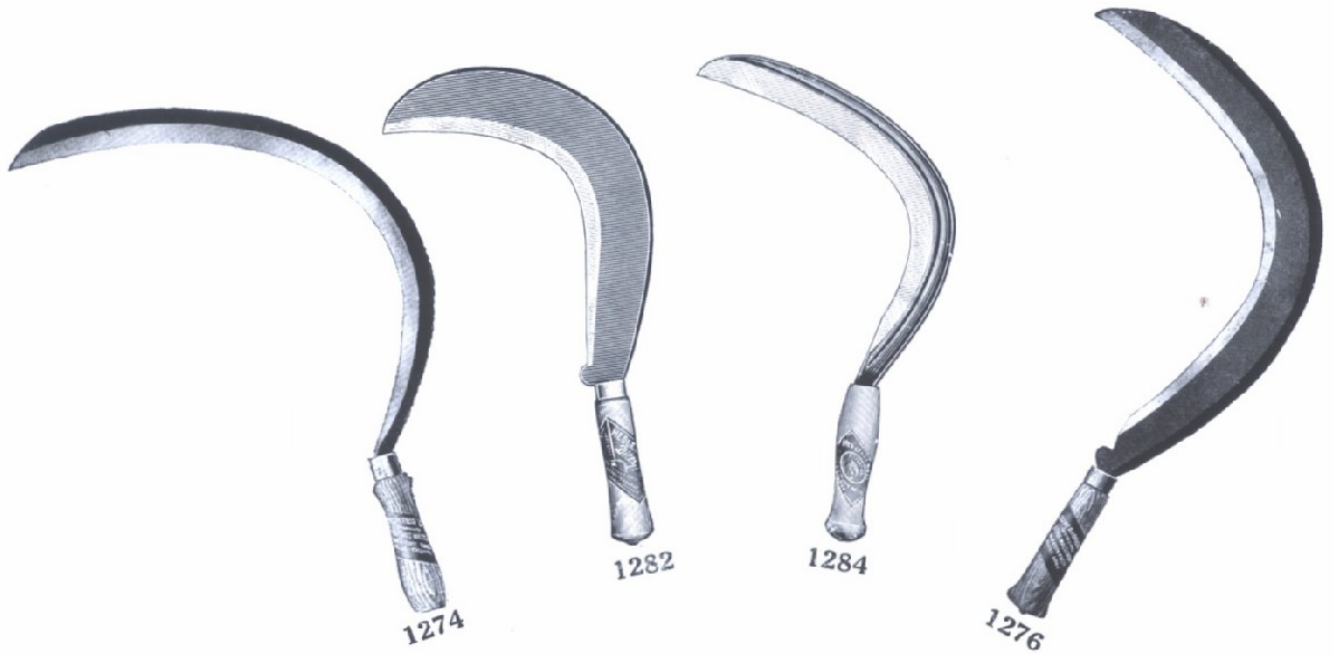

HEDGEHOG



TOOLS.



HEDGEHOG BRAND SUPER-STEEL CHOPPERS

- 318 Household Meat Chopper, Light
- 320 Household Meat Chopper, Superior Grade and Finish
- 319 Butchers' Block Chopper, Medium
- 321 Devon Pattern Chopper
- 322 Lamb Chopper, Round Handle
- 323 Lamb Chopper, Scale Tang Handle
- 323 B Lamb Chopper, Scale Tang Handle
- 326 Smithfield Chopper, Round Handle
- 327 Smithfield Chopper, Scale Tang Handle
- 329 Newcastle Chopper, Scale Tang Handle
Choppers fitted with Finger Grips, extra
- 330 Irish Pattern Chopper
- 337 Scotch Pattern Chopper
- 345 Irish Pattern Heavy Bacon Knife
- 345 B Irish Pattern Heavy Bacon Knife, Scale Tang Handle
- 343 Smithfield Pattern Block Scraper
- 343 F French Pattern Block Scraper



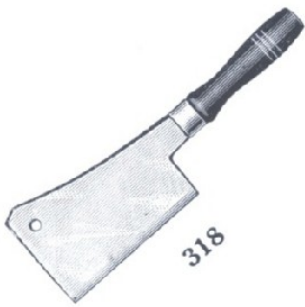

318

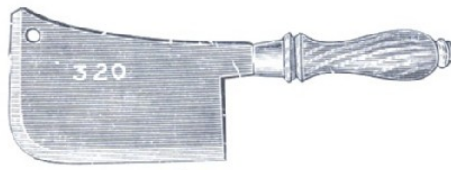

320

320

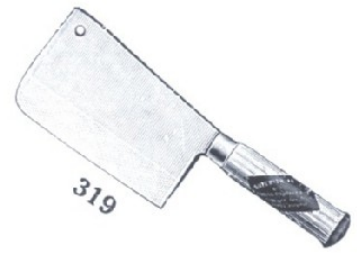

319

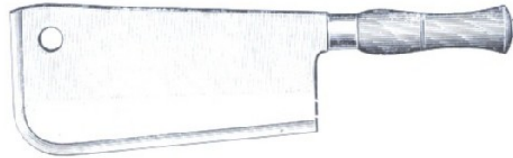

322



323 B



323

HEDGEHOG



TOOLS.

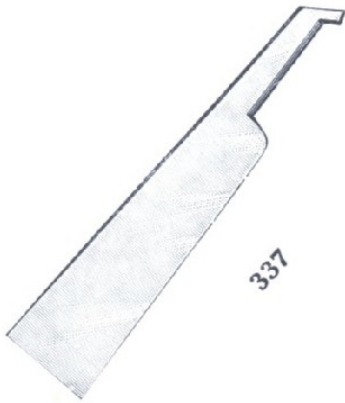

337

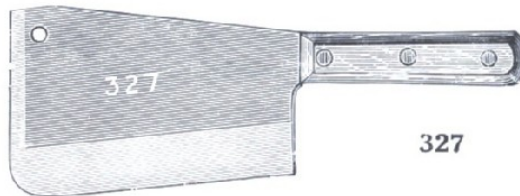

327

327



345

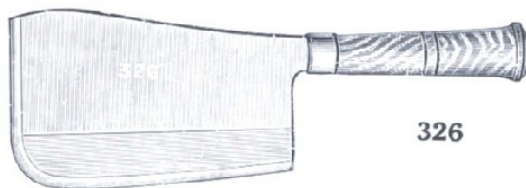

326

326

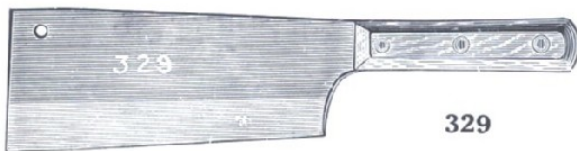

329

329



330

**HEDGEHOG BRAND
SUPER-STEEL CLEAVERS, &c.**

- 336** Smithfield Pattern "Super Steel" Cleaver
- 338** Smithfield Pattern "Super Steel" Cleaver, Scale
Tang Handle
- 338 B** Smithfield Pattern "Super Steel" Cleaver, fitted
with Bolster
- 73** Smithfield Pattern Pole-Axe
- 73 H** Smithfield Pattern Pole-Axe, Handled
- 75 A** Smithfield Pattern Pig Hammer
- 75 H** Smithfield Pattern Pig Hammer, Handled
- 454** Pig Scraper, with Solid Weldless Hook
- 454 A** Pig Scraper, without Hook
- 314** Breast Knives, Bright
- 340** London Wood Chopper, Heavy, Bright and Blued
- 340 L** London Wood Chopper, Light
- 341** Stick Chopper
- BLA** Butchers' Long Arm, Forged Steel, Handled
- HLA** Butchers' Long Arm, Forged Steel, Handled





73

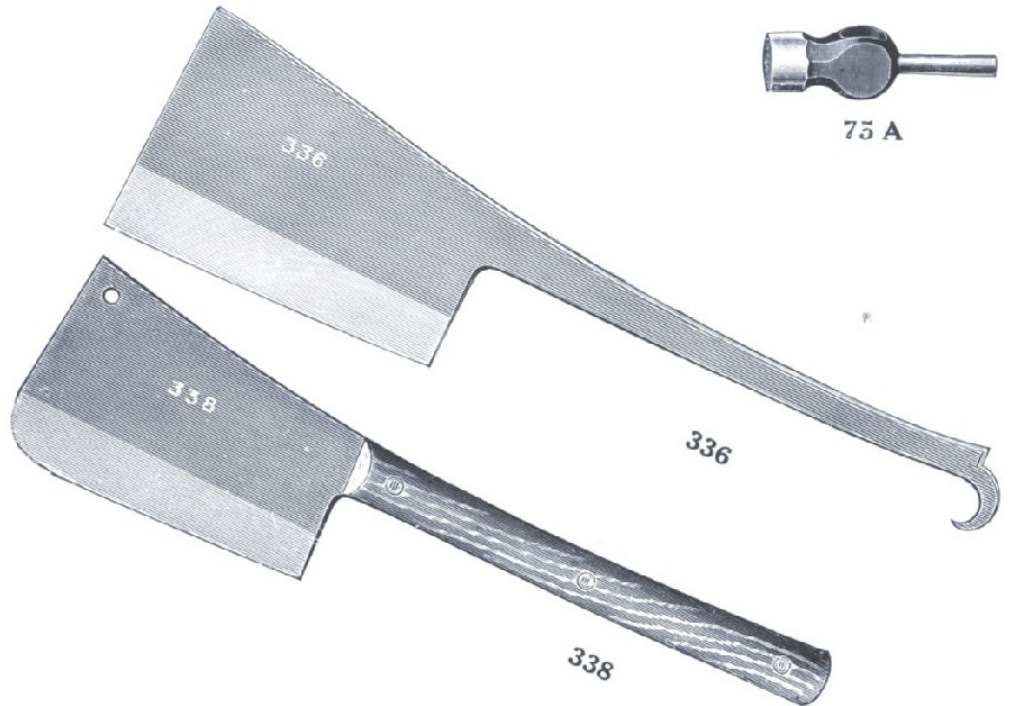

75 A

HEDGEHOG



TOOLS.



BLA

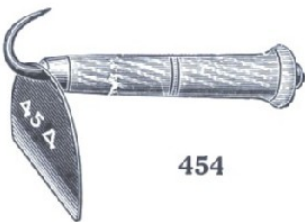

454



340



HLA

HEDGEHOG HAMMERS

- 360 R Joiners' Hammer, Registered Design
- 360 D Joiners' Hammer, Registered Design, Bright
- 361 Riveting Hammer
- 361 D Riveting Hammer, Bright
- 363 Canterbury Hammer, Solid Langets
- 374 AE Adze Eye Pattern Hammer
- 364 Patternmakers' Hammer, Ball Pane
- 364 B Patternmakers' Hammer, Ball Pane, Bright
- 364 A Patternmakers' Hammer, Cross Pane
- 364 F Patternmakers' Hammer, Cross Pane, Bright
- 365 Lathing Hammer, Solid Steel
- 367 Gardeners' Hammer, Spiked
- 369 Farriers' Hammer, Plain English Pattern
- 369 A Ox-Shoeing Hammer, Cape Pattern
- 369 H Farriers' Hammer, American Pattern
- 369 S Farriers' Hammer, Scotch Pattern
- Tack Hammers, Clawed, Handled
- Tack Hammers, Clawed, Bright Handled
- Tin-packers' Hammer, Spiked, Handled
- Case Makers' Hammer, Clawed and Spiked, Handled



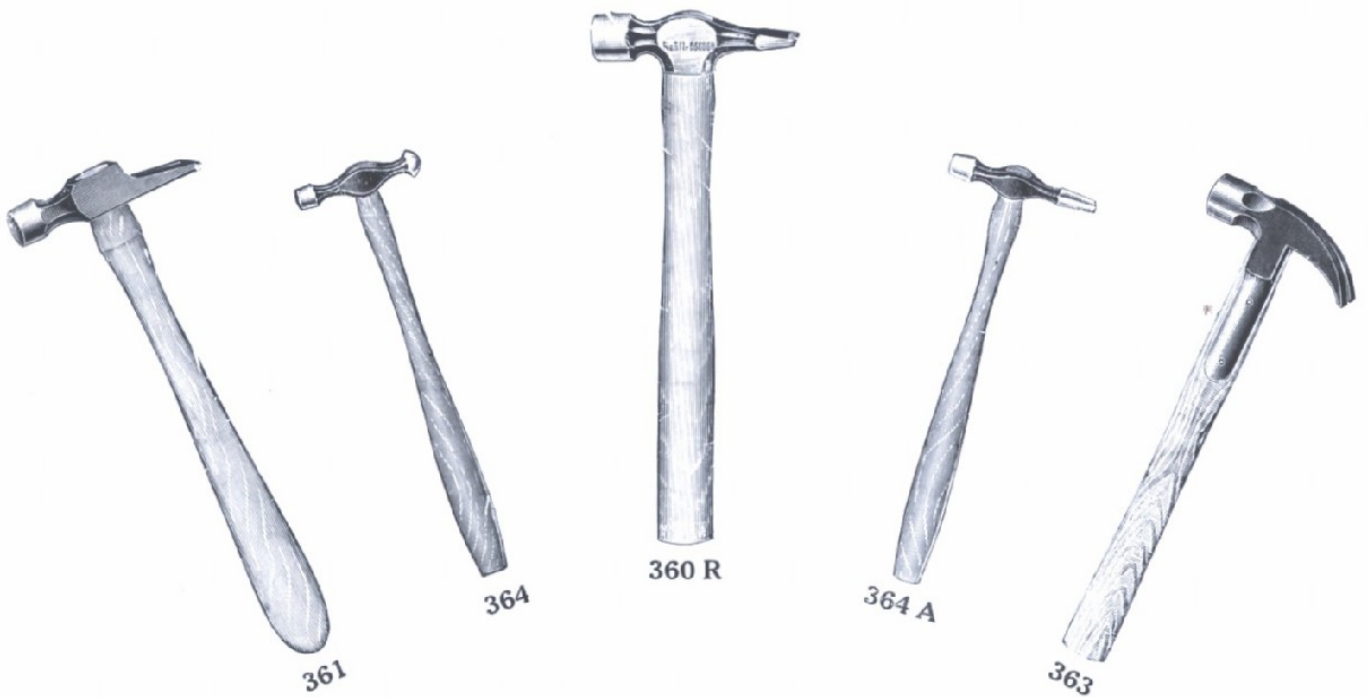

HEDGEHOG



TOOLS.



HEDGEHOG HAMMERS

- 368 Slaters' Hammer, Light, Clawed
- 368 A Slaters' Hammer, Light, without Claw
- 368 S Slaters' Hammer, Strapped, Clawed
- 368 D Slaters' Hammer, Strapped, without Claw
- 371 Packers' Hammer, Black Finish
- 372 Packers' Hammer, Bright Finish
- 372 B Packers' Hammer, Black Finish (shape as 372)
- 380 Orange Case Hammer
- 420 S Farmers' Claw Hammer
- R 10 Case Opener, Registered Design, Mark K.C.
- R 11 Packers' Hammer, Common
- 370 Coal Hammer, Solid Steel
- 370 S Coal Hammer, Strapped
- 378 Shoemakers' Hammer
- 373 B Case Opener, Solid Steel, Self Colour
- 848 Scaffolding Hammer
- 848 F Scaffolding Hammer, Sheathed Handle





HEDGEHOG



TOOLS.



HEDGEHOG HAMMERS

- 385 **Engineers' Hammer**, Ball Pane
 385 B **Engineers' Hammer**, Ball Pane, All Bright
 386 **Engineers' Hammer**, Straight Pane
 386 B **Engineer's Hammer**, Straight Pane, All Bright
 387 **Engineers' Hammer**, Cross Pane
 387 B **Engineers' Hammer**, Cross Pane, All Bright
 386 C **Coopers' Hammer**
 400 **Coachmakers' Hammer**
 403 C **Shoe Turning Hammer**
 404 **Shoe Turning Hammer**
 405 **Shoe Turning Hammer**
 401 **Stone Breaking Hammer**, Black Faces
 401 K **Stone Breaking Hammer**, Bright Faces
 401 A **Stone Napping Hammer**, Bright Faces
 401 B **Ballarat Napping Hammer**, Bright Faces
 401 R **Round Stone Hammer**
 406 A **Sledge Hammer**, Double Face
 406 B **Sledge Hammer**, Straight Pane
 406 **Sledge Hammer**, Cross Pane
 407 **Quarry Hammer**, 2 Rounded Faces
 409 **Boilermakers' Hammer**
 410 **Boilermakers' Hammer**, Shell Riveting
 411 **Boilermakers' Hammer**
 412 **Boilermakers' Hammer**
 413 **Boilermakers' Hammer**, Flogging
 414 **Boilermakers' Hammer**, Liverpool Shell Riveting
 423 **Boilermakers' Hammer**

Any of the above Hammers can be supplied fitted with Ash
or Hickory handles





385



386



387



401



386 C



401 A



400



403 C



405

HEDGEHOG



TOOLS.

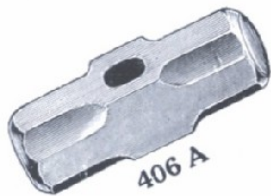

406 A



406 B



406



410



407



412



411



414



423

HEDGEHOG HAMMERS

- 415 Boilermakers' Hammer, Stripping
- 416 Boilermakers' Hammer, Heavy Stripping
- 417 Boilermakers' Hammer
- 418 Boilermakers' Hammer
- 422 Boilermakers' Hammer
- 421 Boiler Chipping Hammer, 16oz.
- 421 H Boiler Chipping Hammer, Handled, 16oz.
- 1794 Platelayers' Spiking Hammer
- 425 Shipwright's Pin Maul
- 430 Mining Drill Hammer
- 514 Masons' Hammer, Long Pattern
- 514 H Mason's Hammer, Long Pattern, Handled
- 515 Mason's or Club Hammer, Short Pattern
- 515 H Masons' or Club Hammer, Short Pattern, Handled
(Illustrated on page 34)
- 516 Spalling Hammer
- 516 A Chisel End Hammer, Oblong Face
- 516 B Chisel End Hammer Square Face
- 516 C Spalling Hammer, Ballarat Deep Pattern
- 518 Masons' Walling Hammer
- 518 F Masons' Walling Hammer
- 1796 Double-faced Hammer, Continental Pattern
- 1797 Cross Pane Hammer, Continental Pattern
- 1798 Keying Hammer, Side Pane
- 1799 Keying Hammer, Centre Pane





425



415



416



417

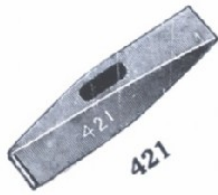

421



1794

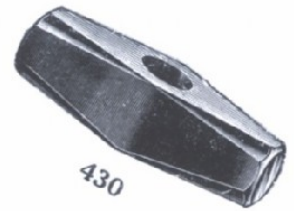

430

HEDGEHOG



TOOLS.



514



1799



515



516



516 A



516 B



518

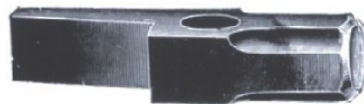

1798

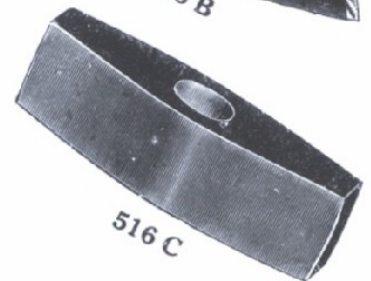

516 C

HEDGEHOG TOOLS

- 431 **Caulking Iron**, Bright
 432 **Caulking Iron**, Bright, Single Crease
 433 **Caulking Iron**, Bright, Double Crease
 434 **Caulking Iron**, Bright, Treble Crease
 435 **Caulking Iron**, Bright, Bent
 436 **Caulking Iron**, Bright, Sharp
 437 **Caulking Iron**, Bright, Trenail
 438 **Caulking Iron**, Bright, Spike
 439 **Caulking Iron**, Bright, Jerry
 439 A **Caulking Iron**, Bright, Jerry, 12in.
 439 R **Caulking Iron**, Bright, Reaming, Fantail
 439 S **Caulking Iron**, Bright, Reaming, Square
 480 A **Nail Puller**, Clawed (32oz.)
 440 **Coppering Chisel**, Clawed
 441 **Coppering Punch**
 443 **Podger End Spanners**
 449 **Marlin Spike**, for Hemp Rope
 449 B **Marlin Spike**, for Wire Rope
 1530 **Plugging Chisel**, Large
 1530 S **Plugging Chisel**, Small
 1534 **Plugging Chisel**, Registered Pattern, Large
 1534 S **Plugging Chisel**, Registered Pattern, Small
 1537 **Round Edge Chisel**, for Galvanized Iron
 1539 **Punch**, for Galvanized Iron
 1540 **Punch**, for Reaper Sections
 1542 **Electricians' Chisel**
 484 **Engineers' Cold Chisels**, manufactured from High-grade
 Hammered Octagon Steel
 481 **Engineers' Chisels**, Cross Cut
 482 **Engineers' Chisels**, Half-round Cut
 483 **Engineers' Chisels**, Diamond Point
 485 **Wall Drill**



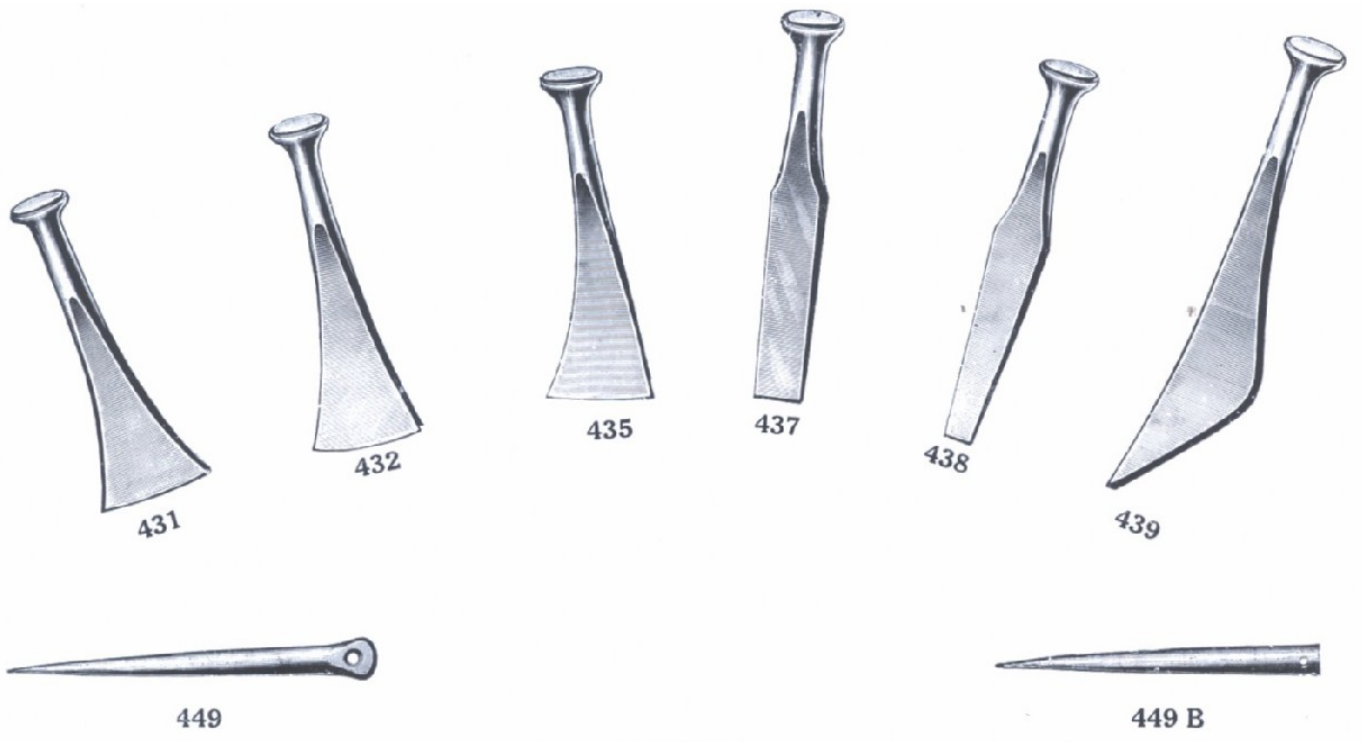

HEDGEHOG



TOOLS.



1534

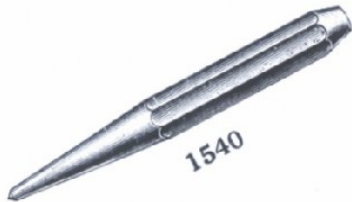

1540



1539



1530



482



483

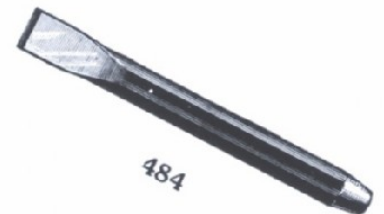

484



443

HEDGEHOG TOOLS

- F 24** Farriers' Pincers, American Pattern
F 28 Farriers' Pincers, English Pattern
F 32 Farriers' Punch or Stamp
F 36 Farriers' Crease
F 40 Farriers' Buffer
F 41 Farriers' Buffer
F 42 Farriers' Buffer
F 48 Farriers' Pritchell, 12 × 5/8in.
470 Mill Bill or Chisel, Finest Silver Steel
473 Mill Pick, Finest Silver Steel, Two Diamond Points
 (Mill Bills and Picks can be Eyed for Wood Handle if desired)
477 Mill Bill Thrift or Handle, Steel, with Wood Handle
477 A Mill Bill Thrift or Handle, Wood
487 Splitting Wedge, Solid Steel
487 A Splitting Wedge, Solid Steel, Thin Pattern (shape as 487)
487 S Splitting Wedge, Solid Steel, Flat Head
487 T Splitting Wedge, Solid Steel, Flat Head, Thin Pattern
487 R Splitting Wedge, Solid Steel, Round Tapered Head
506 A Grubbing Mattock, Short Cutter, Best Quality and Finish
506 L Grubbing Mattock, Long Cutter, Best Quality and Finish
952 Grubbing Mattock, with Undercut, Best Quality and Finish
955 Pick Mattock, Best Quality and Finish
497 Grubbing or Road Mattock, English Pattern



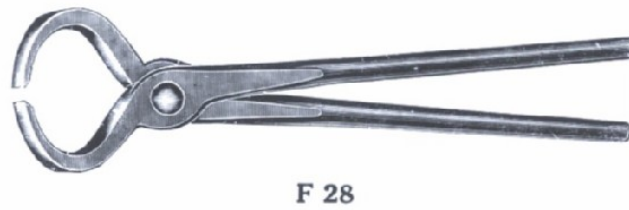
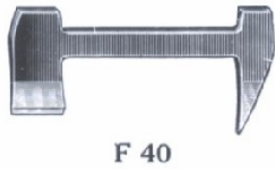
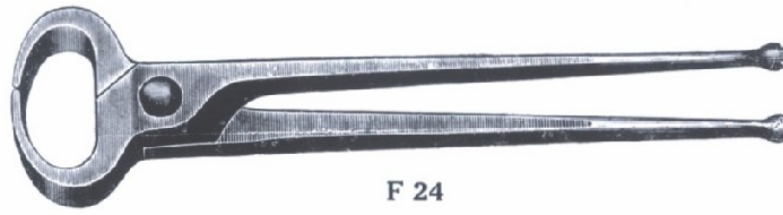

HEDGEHOG



TOOLS.

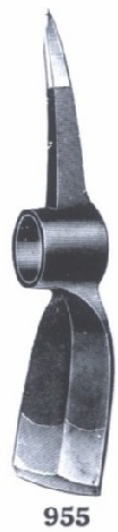

HEDGEHOG MINERS' TOOLS AND PICKS

- 493 **Railway Beater Pick**, T Foot
- 493 A **Railway Beater Pick**, V Foot
- 494 **Road Pick**, 2 Diamond Points
- 494 A **Road Pick**, 2 Bright Points and Japanned
- 495 **Navy Pick**, Point and Chisel
- 495 A **Navy Pick**, Point and Chisel, Bright Ends and Japanned
- 495 W **Navy Pick**, Point and Wide Chisel
- 495 R **Navy Pick**, Point and Wide Chisel, Red Enamelled
- 500 **Hammer Head Pick**
- 501 **Hammer Head Pick**
- 503 **"Drop-on" Pick**, Self Colour
- 504 **Mining Pick**, "Interchangeable," Straight
- 504 B **Mining Pick**, "Interchangeable" Bent
- 502 S **Mining Pick**, Mandrill Pattern, Straight
- 502 **Mining Pick**, Mandrill Pattern, Bent
- 9920 **Mining Dresser Picks**, with strong Langets and Handles
- 2900 **Mining Tool Bar**
- 491 **Mining Wedge**, Flat
- 491 E **Mining Wedge**, Octagon
- 491 B **Mining Wedge**, Flat (or Joey), 8oz.
- 2904 **Mining Lamp Spike**





494



491 E



491



491 B

HEDGEHOG



TOOLS.



502



503



502 S



504



9920



2900

HEDGEHOG BRICKLAYERS' & MASONS' TOOLS

- 512 **Line Pins**, Bright Steel, Oval Blade
- 512 A **Line Pins**, Black Steel, Oval Blade
- 512 D **Line Pins**, Bright Steel, Flat Blade
- 512 E **Line Pins**, Black Steel, Flat Blade
- 512 G **Line Pins**, Bright Steel, Anchor Head
- 512 H **Line Pins**, Black Steel, Anchor Head
- 519 **Masons' Chisel**, Mallet Head
- 520 **Masons' Bolster**, Mallet Head
- 521 **Masons' Point**, Mallet Head
- 523 **Bricklayers' Hammer**, Handled
- 523 B **Bricklayers' Hammer**, Handled, Adze Eye Pattern
- 523 F **Bricklayers' Hammer**, Handled, American Pattern
- 523 S **Bricklayers' Hammer**, Handled, Scotch Pattern
- 523 Z **Bricklayers' Hammer**, Handled, Combination Pattern
(formerly **ZX 7**)
- 524 P **Bricklayers' Mortar Pick**, Handled, Heavy
- 524 L **Bricklayers' Mortar Pick**, Handled, Light
- 526 **Slaters' Axe**
- 526 L **Slaters' Axe**, Light
- 527 **Slaters' Ripper**
- 528 **Bricklayers' Bolster**, Round Handle
- 528 H **Bricklayers' Bolster**, Heavy, Round Handle
- 528 D **Bricklayers' Bolster**, Light, Octagon Handle
- 528 F **Brick Dresser**, Double End, Round Grip
- 528 K **Brick Dresser**, Double End, Eyed, Wood Handle
- 529 **Slaters' Anvil**
- 515 **Masons' or Club Hammer**, Short Pattern
- 515 H **Masons' or Club Hammer**, Handled





523



528 K



523 S



512



529



528

HEDGEHOG



TOOLS.



515 H

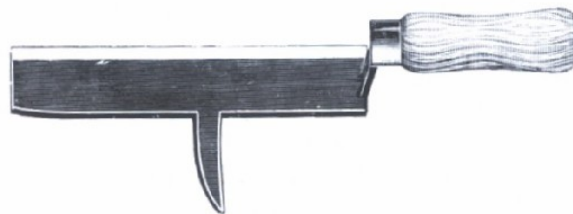

526 L



524 P



521



520



527



519

HEDGEHOG HOES

- 555 Garden Hoe, Riveted, Short Neck
 556 Garden Hoe, Solid, Short Neck
 557 A Garden Hoe, Solid, Long Neck
 557 R Garden Hoe, Riveted, Long Neck
 558 Banbury Hoe, Solid Forged
 558 F Ferrule for Banbury Hoe, No. 558
 560 Bury Hoe, Solid Forged
 560 T Bury Hoe, Solid Forged, Tanged
 561 Diamond Eye Hoe, Solid
 567 Stalham Hoe, Solid Forged Steel
 567 E Ely Hoe, Solid Forged Steel
 567 Y Yarmouth Hoe, Solid Forged Steel
 567 W Woodbridge Hoe, Solid Forged Steel
 567 N Newport Hoe, Solid Forged Steel, Narrow
 567 P Newport Hoe, Solid Forged Steel, Deep
 582 Triangle Hoe, Screwed Sockets
 583 S Dutch Hoe, Solid
 583 R Dutch Hoe, Riveted
 585 Bedford Hoe, Solid Forged Steel
 607 Wheat Hoe, Solid Forged Steel
 607 R Wheat Hoe, Light, Riveted
 608 Axe Eye Hoe, Solid
 608 H Axe Eye Hoe, Solid, Handled
 14/09 Cardigan Hoe
 950 Irish Gruffan, Pick Eye
 950 D Canterbury Hoe, 3-prong
 950 C Canterbury Hoe, 2-prong
 562 Screwed Sockets for Diamond Eye Hoes
 562 H Screwed Sockets for Diamond Eye Hoes, fitted
 with 5ft. Ash Handles
 961 A Potato Hoe, Solid Steel, Blade 7in. × 4in.





HEDGEHOG



TOOLS.

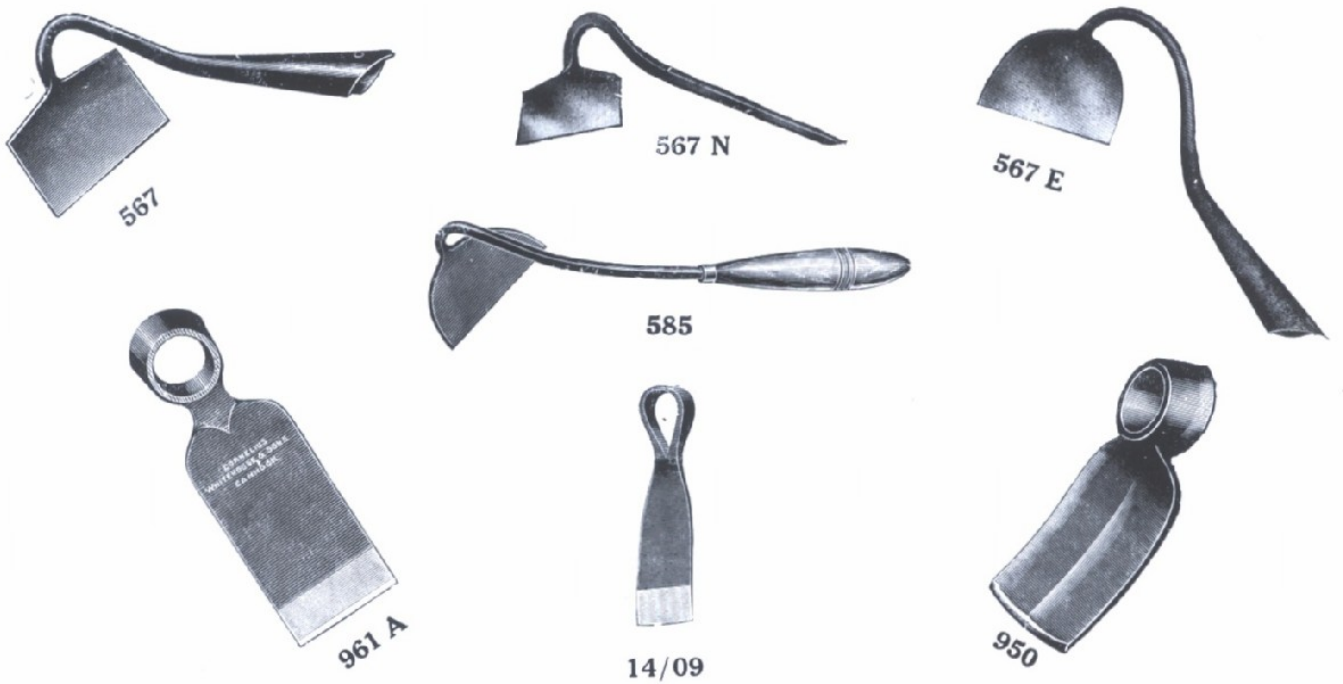

HEDGEHOG TOOLS

- 592 Solid Forged Spud
- 592 A Light Open Socket Spud, shape as 592
- 594 Solid Forged Spud
- 594 A Light Open Socket Spud, shape as 594
- 596 Solid Forged Spud
- 596 A Light Open Socket Spud, shape as 596
- 592 C Special Riveted Spud, shape as 592
- 594 C Special Riveted Spud, shape as 594
- 596 C Special Riveted Spud, shape as 596
- 600 Gent's Strapped Spud, 48in. Handle
- 602 Gent's Strapped Spud, 48in. Handle
- 900 Solid Forged Steel Double Edge Hoe, (not Handled)
- 900 A Solid Forged Steel Double Edge Hoe, with 48in. Handle
- 611 F Solid Forged Steel Edging Iron, Tanged and Ferruled, T Handles
- 959 Neath Pattern Mattocks, Handled
- 959 C Neath Pattern Mattocks, Handled, 2-prong End
- 959 F Neath Pattern Mattocks, Handled, 3-prong End
- 969 "The Andyo" (Registered Mark), 42in. Handle
- 969 P "The Andyo" (Registered Mark), fitted with Light Pick-eye, 42in. Handle
- 615 Solid Turfing Iron
- 615 H Solid Turfing Iron, fitted with T Handles
- 615 D Solid Turfing Iron, fitted with D Handles





959



969



959 C



900 A

HEDGEHOG



TOOLS.



600



602



615



592



594



596



611 F

HEDGEHOG TOOLS

- 960 The "Preston" Hoe, 3-prong
- 961 Potato Hoe, Solid Steel Blades, 7in. × 4in.
- 965 Thistle Hoe, Solid Steel Blades, 6in. × 3in.
- 966 Rabbitters Hoe, Solid Steel Blades, 4in. × 3½in.
- 967 Rabbitters' Hoe, Solid Steel Blades, 5in. × 3in.
- 964 Weed Eradicator, Solid Forged, Bright and Red
- 964 H Weed Eradicator, Solid Forged, Bright and Red, 5ft. Handles
- 964 D Hedgehog Pattern Push Hoe, Solid Steel
- 964 P Push-Pull Hoe
- 8010 Steel Claw Bar, 4½ft. × 1¼in. or over
- 8014 Steel Pinch Bar, 4½ft. × 1¼in. or over
- 8018 Steel Claw Bar, 4½ft. × 1¼in. or over
- 8022 Steel Chisel and Point Bar, 4½ft. × 1¼in. or over
- 8026 Steel Double Chisel Bar, 4½ft. × 1¼in. or over
Bars 8010 to 8026 supplied in any size as desired
- 8040 Road Gad, Pointed, Octagon Steel, 15in. × 1½in. and over
- 8042 Road Gad, Pointed, Square Steel, 15in. × 1½in. and over
Road Gads can be supplied in all sizes
- 620 Garden Reel and Pin, Forged, Flat
- 620 A Garden Reel and Pin, Malleable, Flat
- 621 Garden Reel and Pin, Forged, Triangular





HEDGEHOG



TOOLS.



HEDGEHOG TOOLS

BEST QUALITY

S 8	Blacksmiths' Tongs
S 10	Blacksmiths' Tongs
S 12	Blacksmiths' Tongs
S 14	Blacksmiths' Tongs
S 16	Blacksmiths' Tongs
S 18	Blacksmiths' Tongs
S 26	Blacksmiths' Tongs
F 20	Farriers' Tongs
F 18	Farriers' Tongs, American Pattern, 17in.
S 50	Rivet Tongs
S 51	Rivet Tongs, Plyer Pattern
S 60	Bottom Swage
S 62	Top Swage, Eyed
S 64	Hardie, Straight
S 66	Hardie, Half Round
S 68	Cold Set, Best Cast Steel Quality
S 69	Cold Set, Extra Heavy, for Rail Cutting
S 70	Hot Set, Eyed
S 72	Square Punch
S 74	Round Punch
S 76	Top Fuller, Eyed
S 78	Bottom Fuller
S 80	Set Hammer
S 82	Flattener

Sets, Punches or Top-Tools rodded if desired





HEDGEHOG



TOOLS.



HEDGEHOG TOOLS

510	Hod Socket
511	Plasterers' Server , Forged Steel Blade
517	Plasterers' Hair Drag or Lime Fork
522 A	Mortar Larry , Forged Steel Blade
618	Road Scraper , Best
618 A	Road Scraper , Improved
9440	Hoe Bow , Tanged
9442	Hoe Bow , Socket
9443	Hoe Bow , Socket
9445	Turnip Fork , Socket, Handled
9447	Turnip Fork , Tanged, Handled
288 A	Turnip Hook , Light
287 C	Turnip Hook , Socket, Handled
1125 A	Turnip Hook , Curved
1125 B	Turnip Hook , Spiked
1125 C	Turnip Hook , Spiked, Spike Reversed
572	Hoe Blade , Carbon Steel



HEDGEHOG HAY KNIVES

H 1	Best Crown Hay Knives , Broad Point, Side Handle
H 2	Best Crown Hay Knives , Cross Handle
H 3	Best Crown Hay Knives , Side Handle
H 4	Best Crown Hay Knives , Cross Handle
H 5	Best Crown Hay Knives , Cross Handle, Middle Width
H 6	Best Crown Hay Knives , Side Handle, Middle Width
H 7	Best Crown Hay Knives , Side Handle, Broad Heel, Cross Point
H 8	Best Crown Hay Knives , Cross Handle, Broad Heel, Cross Point
H 9	Best Crown Trussing Knives , Side Handle
H 10	Best Crown Trussing Knives , Cross Handle
H 11	Best Crown Socket Knives , Blade as No. H 8

"Hedgehog" Hay and Trussing Knives are manufactured from a specially high-grade of material giving complete satisfaction



1125 A



1125 B



288 A



572



510



9442



9443

HEDGEHOG



TOOLS.



H 3



618 A

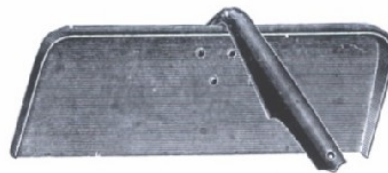

618



522 A

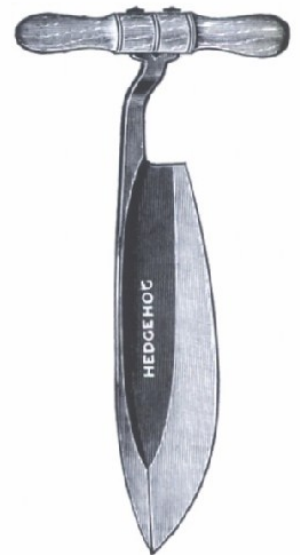

H 4

HEDGEHOG TOOLS

- D 625 Gun Wad Punches
D 652 Hand Vices
D 660 Parallel Vices
- D 670 T Section Cramp, $1\frac{7}{8}$ in. \times $\frac{5}{8}$ in. \times $\frac{1}{4}$ in.
D 675 T Section Cramp, $2\frac{3}{4}$ in. \times $\frac{7}{8}$ in. \times $\frac{1}{4}$ in.
D 671 Lengthening Bar, for Cramp D 670
D 676 Lengthening Bar, for Cramp D 675
- D 683 Improved Joiners' Cramp, $2 \times \frac{1}{2}$ in.
D 685 Improved Sash Cramp, $1\frac{1}{2} \times \frac{5}{16}$ in.
D 687 Improved Sash Cramp, $1\frac{1}{4} \times \frac{1}{4}$ in.
D 689 Improved Sash Cramp, $1\frac{1}{4} \times \frac{1}{4}$ in.
- D 695 Light G Cramp
D 698 Ribbed G Cramp
D 699 Strong G Cramp



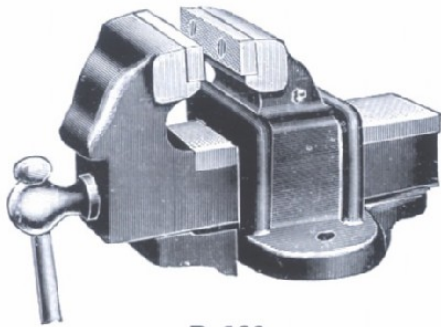

D 660

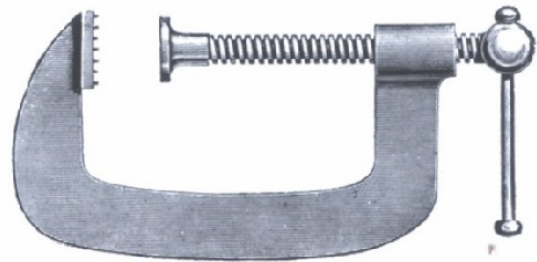

D 699



D 671 and D 676

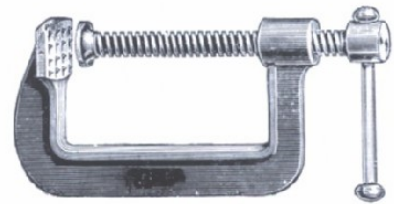

D 698

HEDGEHOG



TOOLS.



D 685 and D 687



D 652

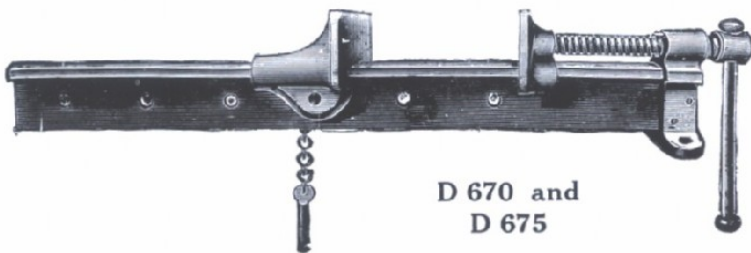

D 670 and
D 675



D 683 and D 689



D 625

HEDGEHOG TOOLS

D 630 Light Tube Vice

D 632 Heavy Tube Vice

* * *

D 638 Clyburn Spanners

* * *

D 666 Bench Stops

D 667 Bench Stops

* * *

D 701 Bench Holdfast

* * *

D 750 Kimberley Pattern Floor Double Prong

D 752 Kimberley Pattern Floor Single Prong

(A pair of D 752 consists of one each Right and Left Hand)



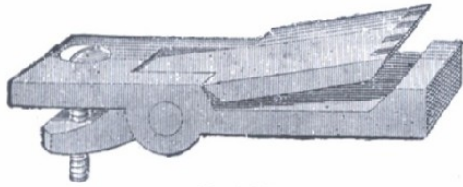

D 667

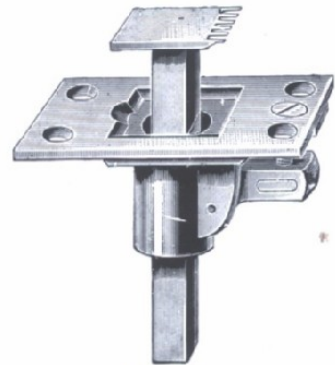

D 666



D 638

HEDGEHOG



TOOLS.

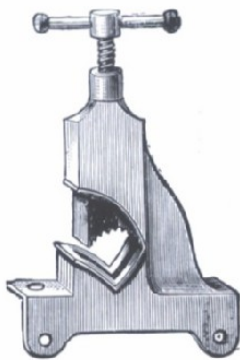

D 630



D 701

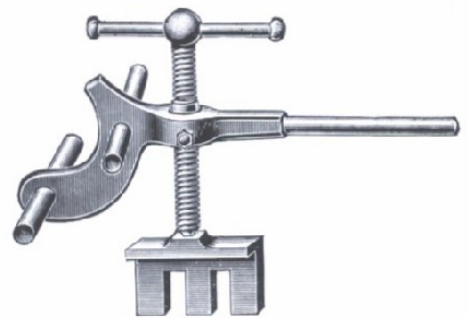

D 750

HEDGEHOG TOOLS

- 2100 Centre Bit, Black
- 2106 Nose Bit, Black
- 2108 Shell Bit, Black
- 2110 Spoon Bit, Black
- 2112 Twist Gimlet Bit, Bright
- 2114 Shell Gimlet Bit, Bright
- 2116 Swiss Gimlet Bit, Bright
- 2118 Square Rimer Bit, Black
- 2120 Rose Countersink Bit, Black
- 2122 Snail Countersink Bit, Black
- 2124 Flat Countersink Bit, Black
- 2131 Brad Awl, Round Beech Handle
- 2143 Twist Gimlet, Square Shank, Box Handle, assorted
 $\frac{1}{8}$ to $\frac{1}{4}$ in.
- 2180 Tower Pincer, Forged Steel
- 9428 Tinman's Snips, Forged Steel
- 9429 Tinman's Snips, Forged Steel, Bent Blade
- 650 S Wheelers' Socket Bruzzes, (16in.)



HEDGEHOG CHISELS

- 639 A C. S. Firmer Chisels, Round Ash Handles
- 639 D C. S. Firmer Chisels, Bevelled Edge
- 639 E C. S. Firmer Chisels, Bevelled Edge, Octagon Boxwood
 Handles

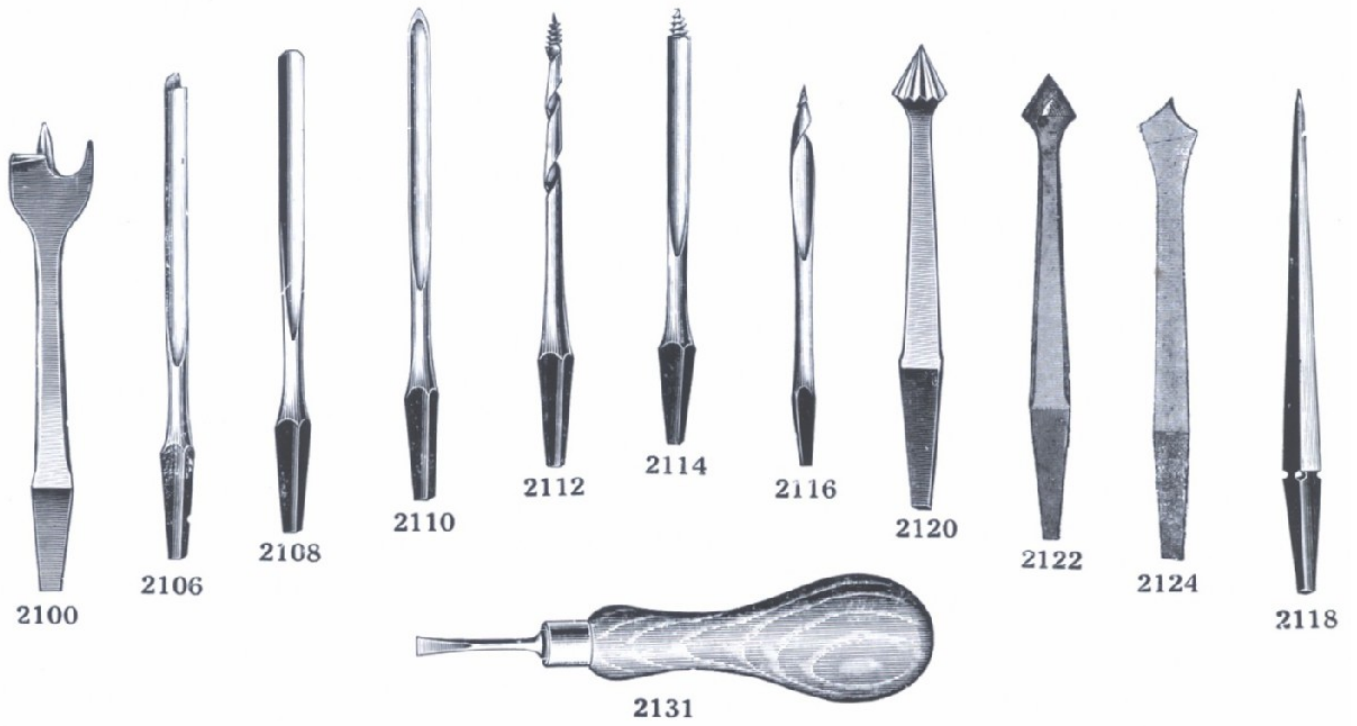

HEDGEHOG



TOOLS.

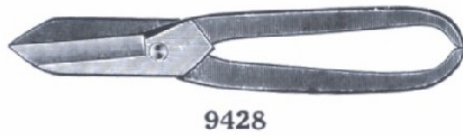

CORNELIUS WHITEHOUSE & SONS, Ltd.

CODE INDEX

DESIGN	PAGE	DESIGN	PAGE	DESIGN	PAGE
A	...	D 670	40	R 10	28
AXB	2	D 671	40	R 11	28
B	1	D 675	40	R 100	4
BB	1	D 676	40	R 107	4
BLA	26	D 683	40	R 115	4
B 18	16	D 685	40	R 124	4
B 19	16	D 687	40	R 133	4
B 19 A	16	D 689	40	RD	1
B 22	21	D 695	40	RE	3
B 22 A	21	D 698	40	RR	1
B 24	21	D 699	40	S 8	38
B 24 A	21	D 701	41	S 10	38
B 24 L	21	D 750	41	S 12	38
B 26	21	D 752	41	S 14	38
C	1	E	2	S 16	38
CT 100	5	F	3	S 18	38
CT 104	5	F 18	38	S 26	38
CT 109	7	F 20	38	S 50	38
CT 112	7	F 24	32	S 51	38
CT 115	9	F 28	32	S 60	38
CT 120	9	F 32	32	S 62	38
CT 124	9	F 36	32	S 64	38
CT 128	9	F 40	32	S 66	38
CT 130	9	F 41	32	S 68	38
CT 132	9	F 42	32	S 69	38
CT 140	9	F 48	32	S 70	38
CT 141	9	H 1	39	S 72	38
CT 144	9	H 2	39	S 74	38
CT 148	9	H 3	39	S 76	38
CT 152	9	H 4	39	S 78	38
CT 156	9	H 5	39	S 80	38
CT 163	9	H 6	39	S 82	38
CT 164	9	H 7	39	I	1
CT 172	9	H 8	39	I G	2
CT 176	9	H 9	39	I XB	2
CT 180	9	H 10	39	2	1
CT 186	9	H 11	39	4	2
D 625	40	H 100	16	4 A	1
D 630	41	H 200	16	5	3
D 632	41	HLA	26	6	1
D 638	41	L	2	6A	1
D 652	40	O 227	13	6 C	1
D 660	40	O 228	13	6E	3
D 666	41	O 229	13	6 G	2
D 667	41	R	1	7	1

CANNOCK EDGE TOOL WORKS, CANNOCK.

CORNELIUS WHITEHOUSE & SONS, Ltd.

CODE INDEX—continued

DESIGN	PAGE	DESIGN	PAGE	DESIGN	PAGE
7 A	1	53 H	6	181	10
7 B	1	55	6	182	10
7 D	1	56	5	184	10
7 F	1	56 A	5	185	10
8	1	57	6	188	10
8 S	1	58	6	189 A	10
9 A	3	59	6	191	10
9 C	3	60	6	192	10
9 E	3	63	6	195	10
9 S	3	63 H	6	196	10
10	3	63 S	6	196 F	10
11	3	73	26	196 S	10
12	2	73 H	26	198	10
13	3	75 A	26	198 A	10
13 A	3	75 H	26	200	10
13 XB	2	78	7	203	10
14	2	80	7	204	10
14/09	35	84	7	204 B	10
14 A	2	85	7	204 D	10
17	2	87	7	205	10
19	3	91	7	205 A	10
20	1	93	7	206	11
26	5	95 S	7	206 A	11
26 A	5	110 A	8	206 B	11
26 S	5	111	8	206 P	11
27	5	114	8	206 S	11
27 H	5	114 C	8	206 X	11
28	5	117	8	207	11
28 H	5	118 A	8	207 A	11
29	5	123 A	8	207 X	11
29 H	5	123 B	8	208	11
29 N	5	124	8	208 A	11
35	5	125	8	208 AX	11
35 H	5	127	9	208 X	11
36	5	127 A	9	209	11
36 H	5	129	9	209 M	11
37	5	132 A	9	209 P	11
37 H	5	133	9	209 S	11
38	5	139	9	209 X	11
41 W	5	139 D	9	210	11
42	5	173	9	210 L	11
45	6	174	10	210 W	11
50	6	174 A	10	210 X	11
52	6	174 D	10	213	12
53	6	178	10	213 A	12

CANNOCK EDGE TOOL WORKS, CANNOCK.

CORNELIUS WHITEHOUSE & SONS, Ltd.

CODE INDEX—*continued*

DESIGN	PAGE	DESIGN	PAGE	DESIGN	PAGE
213 D	12	236	17	287 K	21
213 F	12	237	17	288 A	39
213 H	12	238	17	292	24
213 HP	12	239	17	292 A	15
215	12	239 S	17	292 B	15
215 D	12	240	17	292 D	24
215 F	12	241	17	292 J	24
217	13	242	17	292 M	15
217 A	13	244	17	292 SR	15
217 B	13	245	17	292 SX	15
217 BA	13	247	17	293	23
217 E	13	248	17	294 S	16
217 M	13	250	17	314	26
218	13	251	18	317	24
218 M	13	252	18	318	25
219	14	253	20	319	25
220	12	254	18	320	25
220 G	12	255	14	321	25
220 M	12	255 T	14	322	25
221	12	256	14	323	25
221 A	12	256 S	14	323 B	25
221 C	12	256 W	14	326	25
221 D	12	257	15	327	25
221 E	12	257 S	15	329	25
221 F	12	260	20	330	25
221 L	12	261	20	336	26
221 M	12	263	20	337	25
222	13	264	20	338	26
223	13	265	20	338 B	26
225	12	265 H	20	340	26
225 D	12	266	20	340 L	26
225 F	12	266 H	20	341	26
225 L	12	271	20	343	25
225 M	12	276	20	343 F	25
226	14	276 A	20	345	25
226 A	14	281	20	345 B	25
226 B	14	281 H	20	360 D	27
227	12	282	20	360 R	27
230	13	282 H	20	361	27
231	13	285	20	361 D	27
232 A	15	287	21	363	27
232 S	15	287 A	21	364	27
234	17	287 C	39	364 A	27
234 P	17	287 D	21	364 B	27
235	17	287 E	21	364 F	27

CANNOCK EDGE TOOL WORKS, CANNOCK.

CORNELIUS WHITEHOUSE & SONS, Ltd.

CODE INDEX—*continued*

DESIGN	PAGE	DESIGN	PAGE	DESIGN	PAGE
365	27	415	30	487 R	32
367	27	416	30	487 S	32
368	28	417	30	487 T	*32
368 A	28	418	30	491	33
368 D	28	420 S	28	491 B	33
368 S	28	421	30	491 E	33
369	27	421 H	30	493	33
369 A	27	422	30	493 A	33
369 H	27	423	29	494	33
369 S	27	425	30	494 A	33
370	28	430	30	495	33
370 S	28	431	31	495 A	33
371	28	432	31	495 R	33
372	28	433	31	495 W	33
372 B	28	434	31	497	32
373 B	28	435	31	500	33
374 AE	27	436	31	501	33
378	28	437	31	502	33
380	28	438	31	502 S	33
385	29	439	31	503	33
385 B	29	439 A	31	504	33
386	29	439 R	31	504 B	33
386 B	29	439 S	31	506 A	32
386 C	29	440	31	506 L	32
387	29	441	31	510	39
387 B	29	443	31	511	39
400	29	449	31	512	34
401	29	449 B	31	512 A	34
401 A	29	454	26	512 D	34
401 B	29	454 A	26	512 E	34
401 K	29	463	20	512 G	34
401 R	29	464	20	512 H	34
403 C	29	470	32	514	30
404	29	472	1	514 H	30
405	29	473	32	515	30, 34
406	29	477	32	515 H	30, 34
406 A	29	477 A	32	516	30
406 B	29	480 A	31	516 A	30
407	29	481	31	516 B	30
409	29	482	31	516 C	30
410	29	483	31	517	39
411	29	484	31	518	30
412	29	485	31	518 F	30
413	29	487	32	519	34
414	29	487 A	32	520	34

CANNOCK EDGE TOOL WORKS, CANNOCK.

CORNELIUS WHITEHOUSE & SONS, Ltd.

CODE INDEX—continued

DESIGN	PAGE	DESIGN	PAGE	DESIGN	PAGE
521	34	594 A	36	964 D	37
522 A	39	594 C	36	964 H	37
523	34	596	36	964 P	37
523 B	34	596 A	36	965	37
523 F	34	596 C	36	966	37
523 S	34	600	36	967	37
523 Z	34	602	36	969	36
524 L	34	607	35	969 P	36
524 P	34	607 R	35	1000	9
526	34	608	35	1100	18
526 L	34	608 H	35	1102	18
527	34	611 F	36	1102 S	18
528	34	615	36	1104	18
528 D	34	615 D	36	1104 S	18
528 F	34	615 H	36	1106	18
528 H	34	618	39	1106 S	18
528 K	34	618 A	39	1108	18
529	34	620	37	1109	18
544	19	620 A	37	1110	18
555	35	621	37	1110 A	18
556	35	639 A	42	1112	18
557 A	35	639 D	42	1113	18
557 R	35	639 E	42	1114	18
558	35	650 S	42	1115	19
558 F	35	716	16	1116	19
560	35	720	16	1117	19
560 T	35	722 C	16	1118	19
561	35	724 C	16	1120	19
562	35	848	28	1121	19
562 H	35	848 F	28	1122	19
567	35	850	8	1123	19
567 E	35	900	36	1124	19
567 N	35	900 A	36	1125 A	39
567 P	35	950	35	1125 B	39
567 W	35	950 C	35	1125 C	39
567 Y	35	950 D	35	1145	19
572 *	39	952	32	1146	19
582	35	955	32	1147	19
583 R	35	959	36	1149	19
583 S	35	959 C	36	1149 S	19
585	35	959 F	36	1151	19
592	36	960	37	1175	20
592 A	36	961	37	1175 H	20
592 C	36	961 A	35	1200	21
594	36	964	37	1202	21

CANNOCK EDGE TOOL WORKS, CANNOCK.

CORNELIUS WHITEHOUSE & SONS, Ltd.

CODE INDEX—*continued*

DESIGN	PAGE	DESIGN	PAGE	DESIGN	PAGE
1204	21	1260	23	1799	30
1206	21	1262	23	2100	42
1208	21	1264	23	2106	42
1210	21	1266	23	2108	42
1212	21	1266 A	23	2110	42
1214	21	1268	23	2112	42
1216	21	1270	23	2114	42
1218	22	1272	23	2116	42
1222	22	1274	24	2118	42
1224	22	1276	24	2120	42
1226	22	1278	24	2122	42
1228	22	1280	24	2124	42
1230	22	1282	24	2131	42
1232	22	1284	24	2143	42
1234	22	1286	24	2180	42
1234 A	22	1288	24	2900	33
1236	22	1289	24	2904	33
1238	22	1330	24	8010	37
1240	22	1331	24	8014	37
1242	22	1530	31	8018	37
1244	22	1530 S	31	8022	37
1246	22	1534	31	8026	37
1248	22	1534 S	31	8040	37
1250	22	1537	31	8042	37
1251	23	1539	31	9428	42
1252	23	1540	31	9429	42
1253	23	1542	31	9440	39
1254	23	1794	30	9442	39
1255	23	1796	30	9443	39
1256	23	1797	30	9445	39
1257	23	1798	30	9447	39
1258	23			9920	33

For details of Alphabetical Index
see front pages of catalogue.

CANNOCK EDGE TOOL WORKS, CANNOCK.

Printed in England by
JOSEPH WONES LTD.
WEST BROMWICH, STAFFS.

**"HEDGEHOG"
TOOLS**

CORNELIUS WHITEHOUSE and SONS, Ltd.

